

Distributed Operating Systems

Synchronization in Parallel Systems

Till Smejkal

2018

Overview

- Introduction
- Hardware Primitives
- Synchronization with Locks (Part I)
 - Properties
 - Locks
 - Spin Lock (Test & Set Lock)
 - Test & Test & Set Lock
 - Ticket Lock
- Synchronization without Locks
- Synchronization with Locks (Part II)
 - MCS Lock
 - Performance
 - Special Issues
 - Timeouts
 - Reader Writer Lock
 - Lockholder Preemption
 - Monitor, Mwait

Introduction

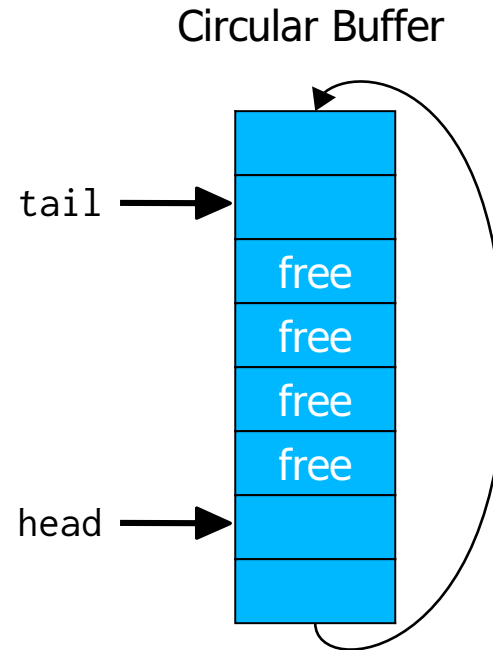
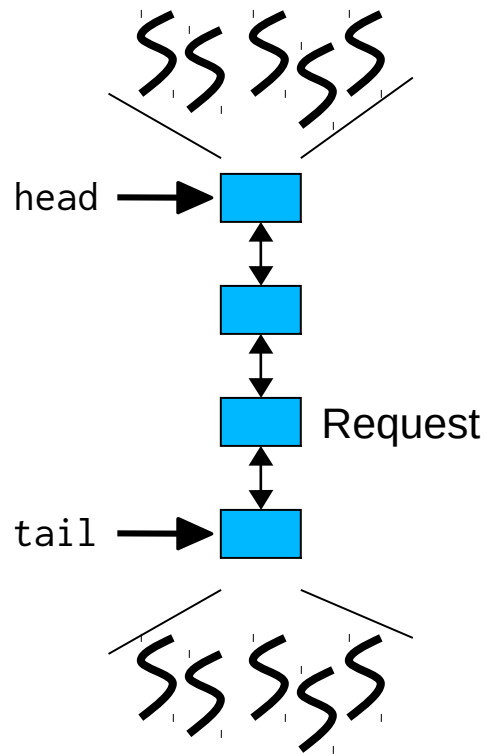

Introduction

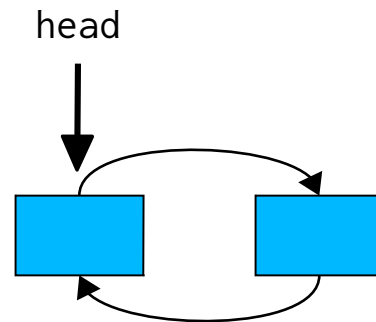

Introduction

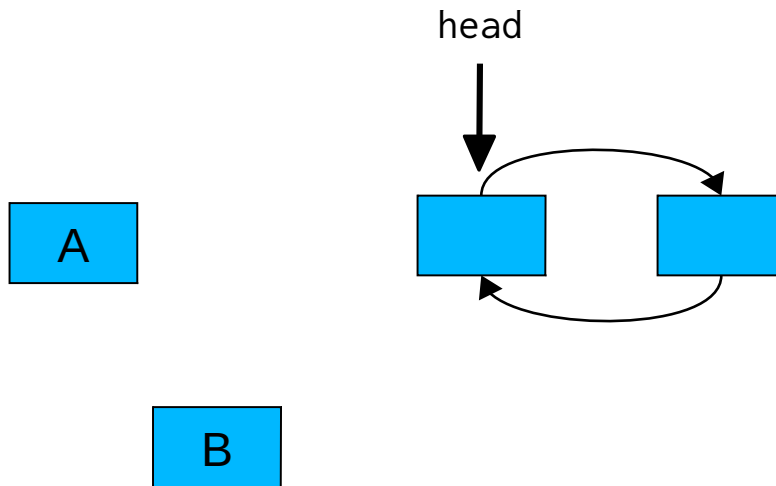

1) A,B create list element

Introduction

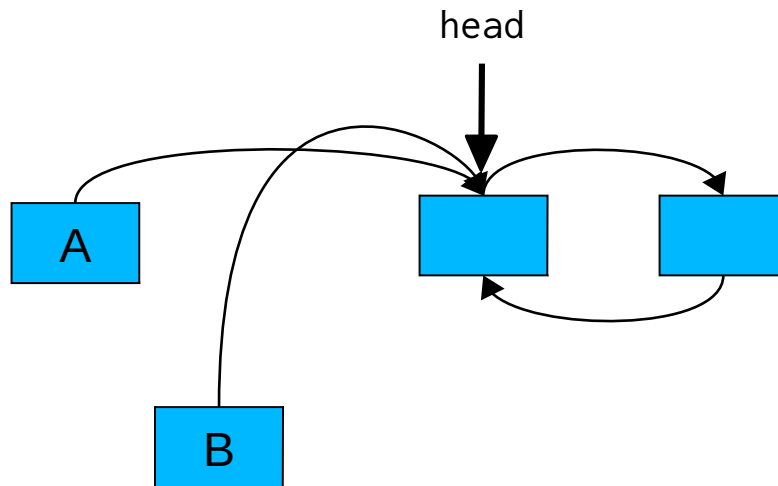

- 1) A,B create list element
- 2) A,B set next pointer

Introduction

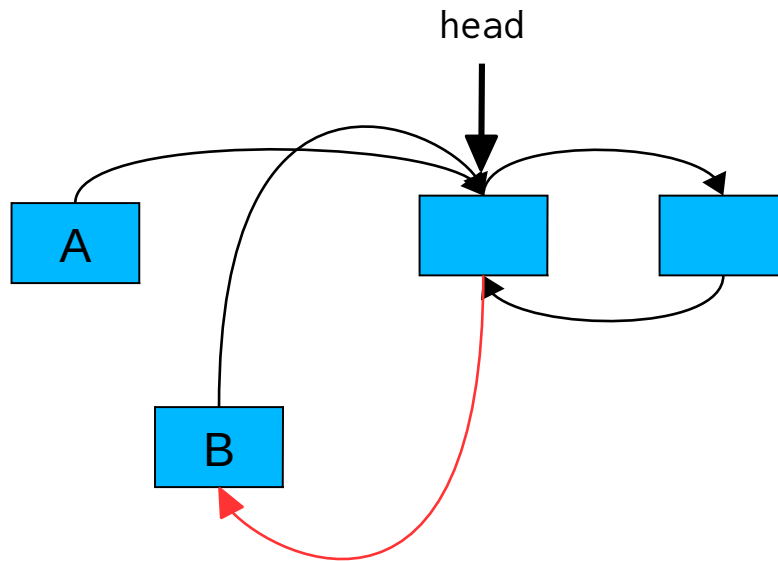

- 1) A,B create list element
- 2) A,B set next pointer
- 3) B sets prev pointer

Introduction

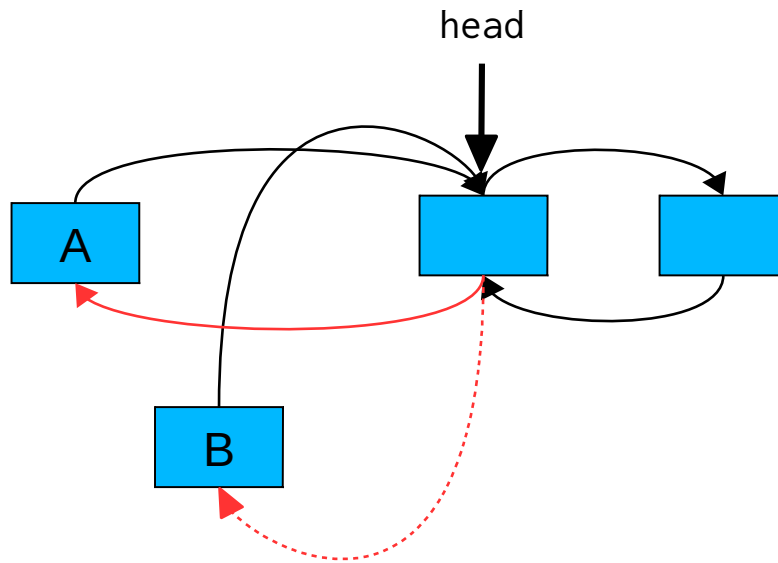

- 1) A,B create list element
- 2) A,B set next pointer
- 3) B sets prev pointer
- 4) A sets prev pointer

Introduction

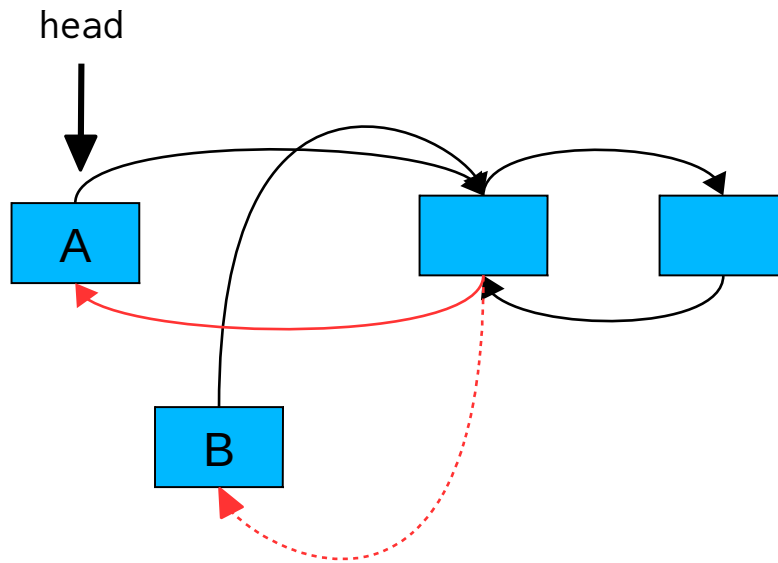

- 1) A,B create list element
- 2) A,B set next pointer
- 3) B sets prev pointer
- 4) A sets prev pointer
- 5) A updates head

Introduction

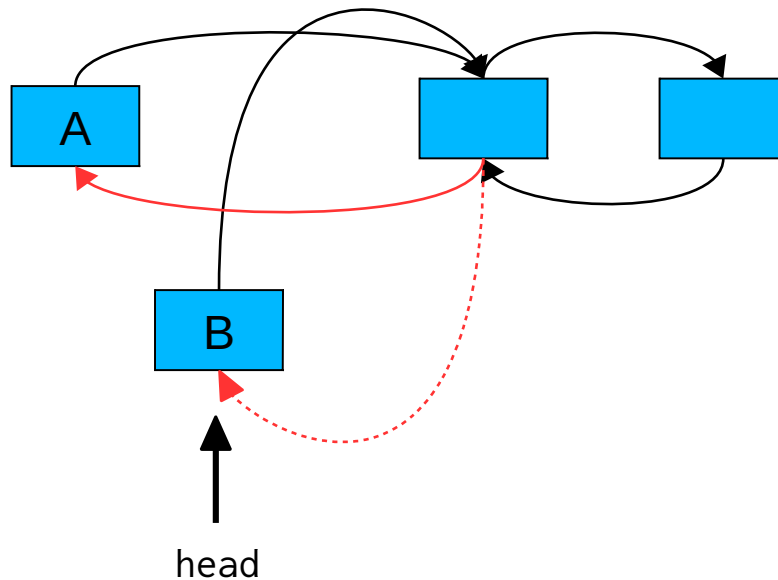

- 1) A,B create list element
- 2) A,B set next pointer
- 3) B sets prev pointer
- 4) A sets prev pointer
- 5) A updates head
- 6) B updates head

Mutual Exclusion – w/ Locks

coarse grained (lock entire list)

```
lock(list);  
list->insert_element(ele);  
unlock(list);
```

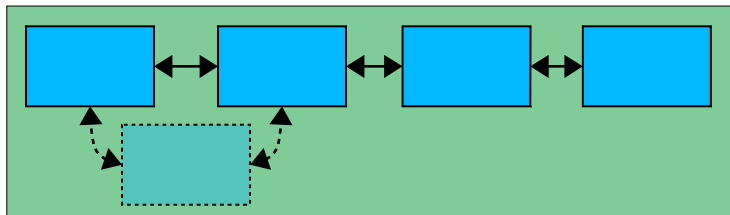

fine grained (lock list elements)

```
retry:  
lock(head);  
if (trylock(head->next)) {  
    head->insert_element(ele);  
    unlock(head->next);  
} else {  
    unlock(head);  
    goto retry;  
}  
unlock(head)
```

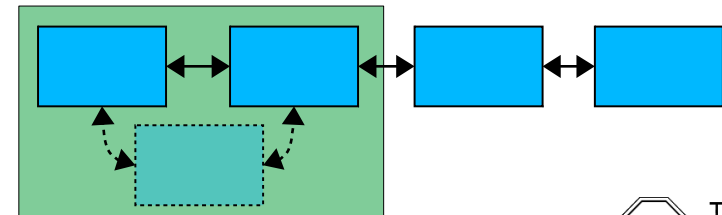

Mutual Exclusion – w/o Locks

Decker / Peterson

- atomic stores, atomic loads
- sequential consistent memory (or memory fences)

```
bool flag[2] = {false, false};
int turn = 0;

void entersection(int thread) {
    int other = 1 - thread;           /* id of other thread; thread in {0,1} */
    flag[thread] = true;              /* show interest */
    turn = other;                     /* give precedence to other thread */
    while (turn == other && flag[other]) {} /* wait */
}

void leavesection(int thread) {
    flag[thread] = false;
}
```

Atomic Hardware Instructions

- A, B are atomic if $A \parallel B = A;B$ or $B;A$
- Read-Modify-Write instructions are typically not atomic

```
      A                          B
add &x, 1      ||      mov &x, 2      (x = 0)
```

Atomic Hardware Instructions

- A, B are atomic if $A \parallel B = A;B$ or $B;A$
- Read-Modify-Write instructions are typically not atomic

A		B	
load &x -> Reg			(x = 0)
add Reg, 1		store 2 -> &x	
store Reg -> &x			

Atomic Hardware Instructions

- A, B are atomic if $A \parallel B = A;B$ or $B;A$
- Read-Modify-Write instructions are typically not atomic

A	B	
load &x -> Reg		(x = 0)
add Reg, 1		
	store 2 -> &x	
store Reg -> &x		

```
x == 1
A;B → x == 2
B;A → x == 3
```

Atomic Hardware Instructions

How to make instructions atomic?

- Bus lock

- Lock memory bus until all memory accesses of a RMW instruction have completed
- Intel Pentium 3 and older x86 CPUs

```
lock; add &x, 1; unlock
```

- Cache Lock

- Delay snoop traffic until all memory accesses of a RMW instruction have completed
- Intel Pentium 4 and newer x86 CPUs

Atomic Hardware Instructions

How to make instructions atomic?

■ Observe Cache

- Install cache watchdog on load
- Abort store if watchdog has detected a concurrent access; retry OP
- ARM, Alpha

```
retry:
    load_linked &x -> Reg;
    modify Reg;
    if (!store_conditional(Reg -> &x))
        goto retry
```

■ Hardware Transactional Memory

- Install watchdog for all memory used by the transaction
- Discard changes on write-write or write-read conflicts
- Intel TSX, IBM BlueGeneQ

Atomic Hardware Instructions

How to make instructions atomic?

- Cache Lock

- Delay snoop traffic until all memory accesses of a RMW instruction have completed
- Can be achieved with the M(O)ESI Cache Coherence protocol

add &x, 1

1. read_for_ownership(&x)
2. load &x -> Reg
3. add Reg, 1
4. store Reg -> &x

mov &x, 2

2. store 2 -> &x

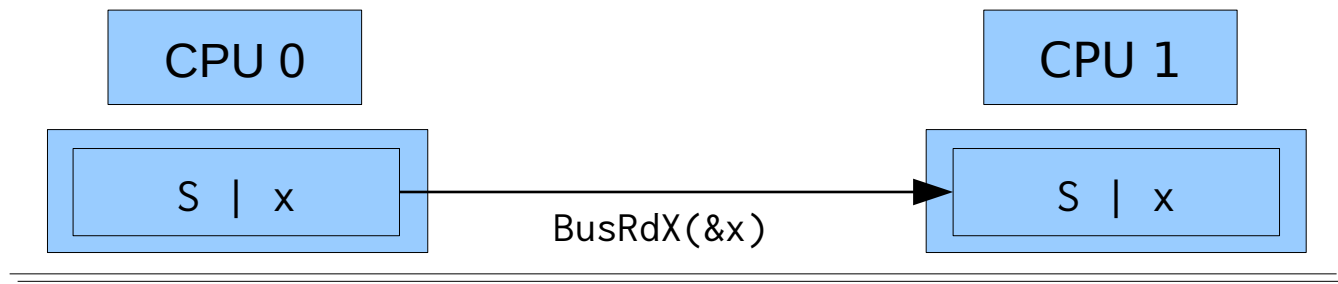

Atomic Hardware Instructions

How to make instructions atomic?

- Cache Lock

- Delay snoop traffic until all memory accesses of a RMW instruction have completed
- Can be achieved with the M(O)ESI Cache Coherence protocol

add &x, 1

1. read_for_ownership(&x)
2. load &x -> Reg
3. add Reg, 1
4. store Reg -> &x

mov &x, 2

2. store 2 -> &x

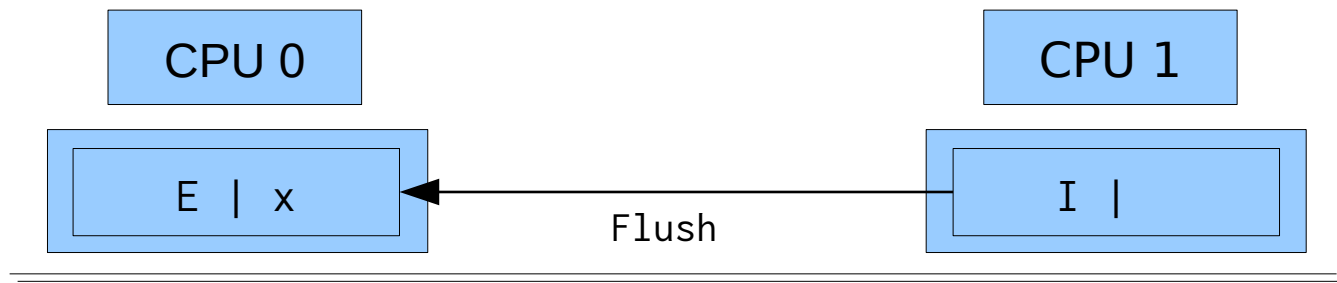

Atomic Hardware Instructions

How to make instructions atomic?

- Cache Lock

- Delay snoop traffic until all memory accesses of a RMW instruction have completed
- Can be achieved with the M(O)ESI Cache Coherence protocol

add &x, 1

1. read_for_ownership(&x)
2. **load &x -> Reg**
3. add Reg, 1
4. store Reg -> &x

mov &x, 2

2. **store 2 -> &x**

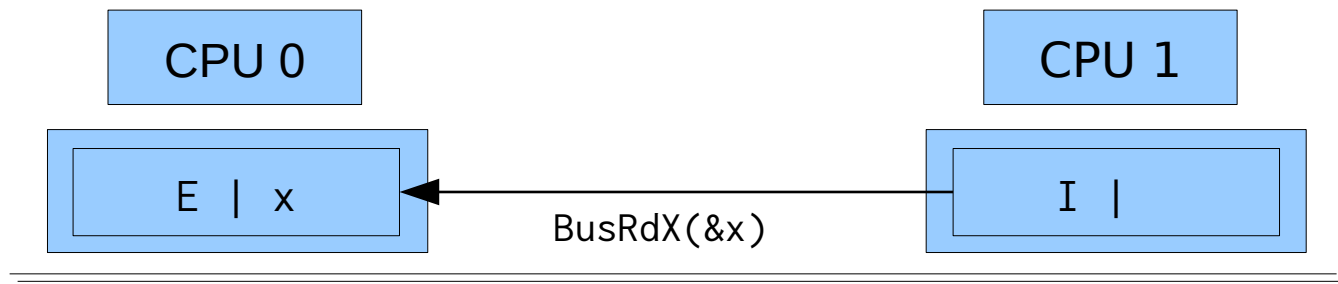

Atomic Hardware Instructions

How to make instructions atomic?

- Cache Lock

- Delay snoop traffic until all memory accesses of a RMW instruction have completed
- Can be achieved with the M(O)ESI Cache Coherence protocol

add &x, 1

1. read_for_ownership(&x)
2. **load &x -> Reg**
3. add Reg, 1
4. store Reg -> &x

mov &x, 2

2. **store 2 -> &x**

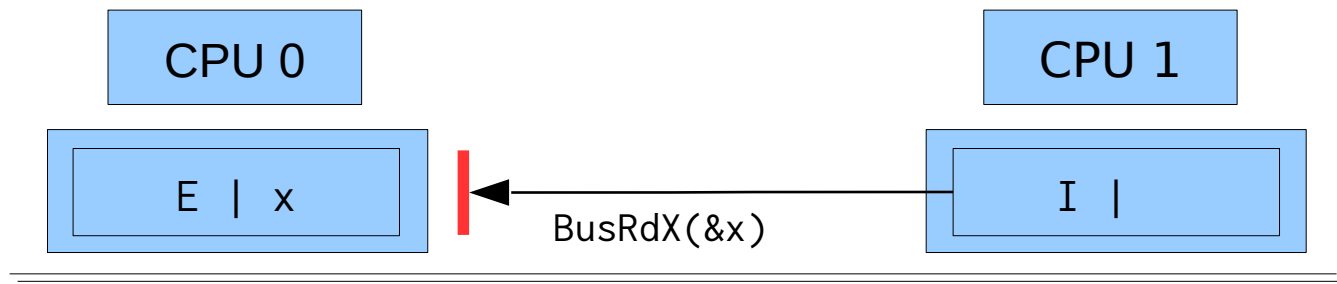

Atomic Hardware Instructions

How to make instructions atomic?

- Cache Lock

- Delay snoop traffic until all memory accesses of a RMW instruction have completed
- Can be achieved with the M(O)ESI Cache Coherence protocol

add &x, 1

1. read_for_ownership(&x)
2. load &x -> Reg
3. **add Reg, 1**
4. store Reg -> &x

mov &x, 2

2. **store 2 -> &x**

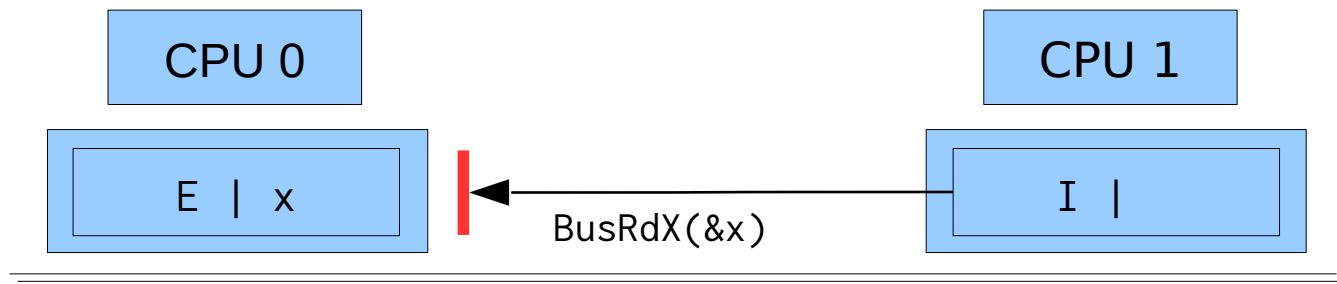

Atomic Hardware Instructions

How to make instructions atomic?

- Cache Lock

- Delay snoop traffic until all memory accesses of a RMW instruction have completed
- Can be achieved with the M(O)ESI Cache Coherence protocol

add &x, 1

1. read_for_ownership(&x)
2. load &x -> Reg
3. add Reg, 1
4. **store Reg -> &x**

mov &x, 2

2. store 2 -> &x

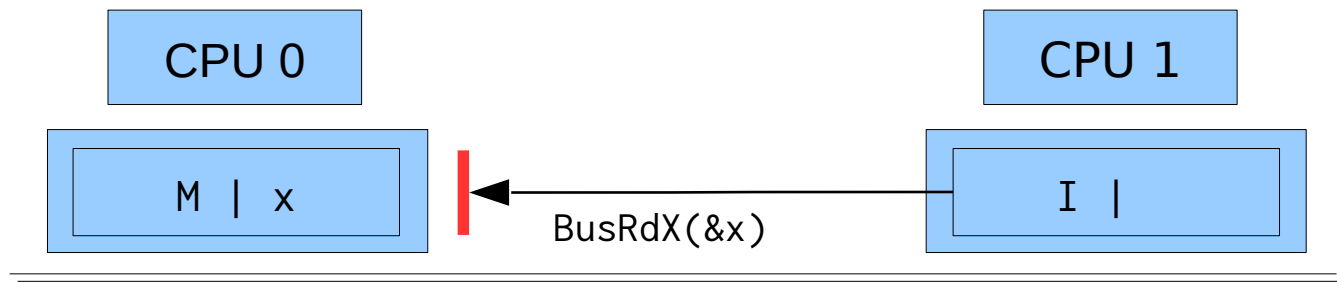

Atomic Hardware Instructions

How to make instructions atomic?

- Cache Lock

- Delay snoop traffic until all memory accesses of a RMW instruction have completed
- Can be achieved with the M(O)ESI Cache Coherence protocol

add &x, 1

1. read_for_ownership(&x)
2. load &x -> Reg
3. add Reg, 1
4. **store Reg -> &x**

mov &x, 2

2. **store 2 -> &x**

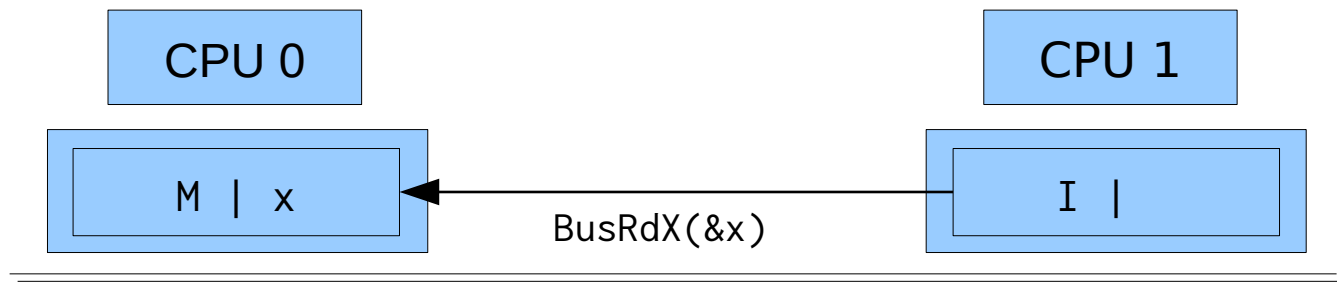

Atomic Hardware Instructions

How to make instructions atomic?

- Cache Lock

- Delay snoop traffic until all memory accesses of a RMW instruction have completed
- Can be achieved with the M(O)ESI Cache Coherence protocol

add &x, 1

1. read_for_ownership(&x)
2. load &x -> Reg
3. add Reg, 1
4. **store Reg -> &x**

mov &x, 2

2. **store 2 -> &x**

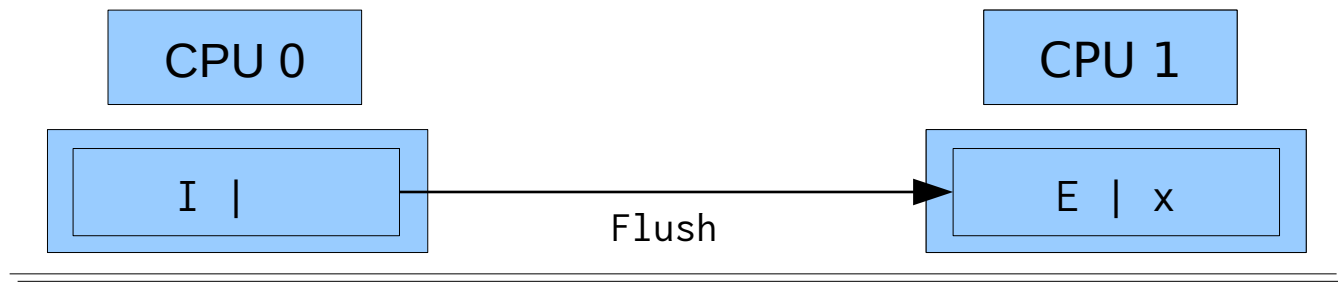

Atomic Hardware Instructions

How to make instructions atomic?

- Cache Lock

- Delay snoop traffic until all memory accesses of a RMW instruction have completed
- Can be achieved with the M(O)ESI Cache Coherence protocol

add &x, 1

1. read_for_ownership(&x)
2. load &x -> Reg
3. add Reg, 1
4. store Reg -> &x

mov &x, 2

2. store 2 -> &x



Atomic Hardware Instructions

How to make instructions atomic?

- Observe Cache

- Install cache watchdog on load
- Abort store if watchdog has detected a concurrent access; retry OP

add &x, 1

1. `load_linked &x -> Reg`
2. `add Reg, 1`
3. `store_conditional Reg -> &x`



Atomic Hardware Instructions

How to make instructions atomic?

- Observe Cache

- Install cache watchdog on load
- Abort store if watchdog has detected a concurrent access; retry OP

add &x, 1

1. **load_linked** &x -> Reg
2. add Reg, 1
3. **store_conditional** Reg -> &x

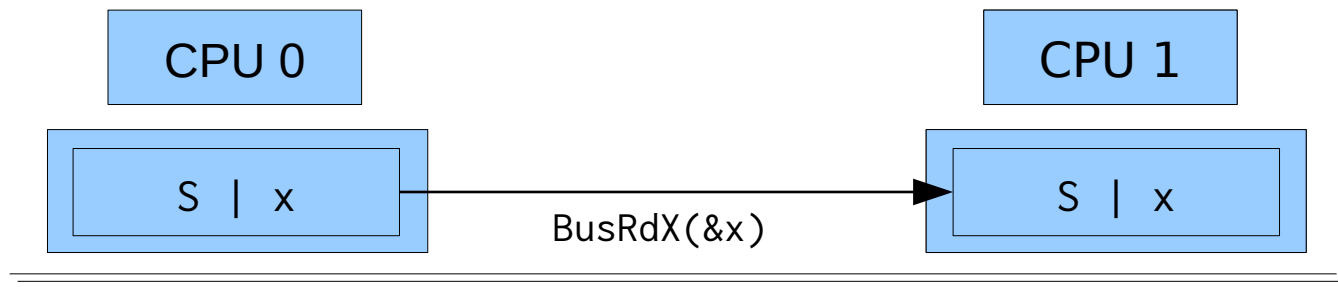

Atomic Hardware Instructions

How to make instructions atomic?

- Observe Cache

- Install cache watchdog on load
- Abort store if watchdog has detected a concurrent access; retry OP

add &x, 1

1. **load_linked** &x -> Reg
2. add Reg, 1
3. **store_conditional** Reg -> &x

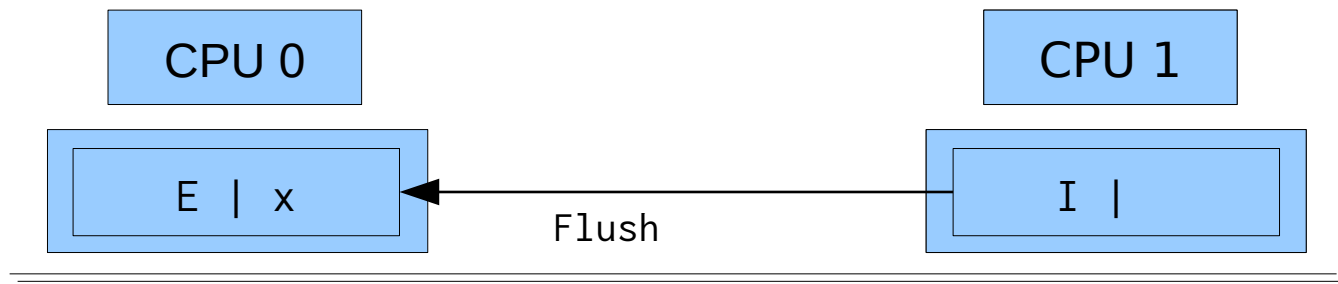

Atomic Hardware Instructions

How to make instructions atomic?

- Observe Cache

- Install cache watchdog on load
- Abort store if watchdog has detected a concurrent access; retry OP

add &x, 1

1. `load_linked &x -> Reg`
2. **add Reg, 1**
3. `store_conditional Reg -> &x`



Atomic Hardware Instructions

How to make instructions atomic?

- Observe Cache

- Install cache watchdog on load
- Abort store if watchdog has detected a concurrent access; retry OP

add &x, 1

1. `load_linked &x -> Reg`
2. `add Reg, 1`
3. **`store_conditional Reg -> &x`**

→ **Ok**



Atomic Hardware Instructions

How to make instructions atomic?

- Observe Cache

- Install cache watchdog on load
- Abort store if watchdog has detected a concurrent access; retry OP

add &x, 1

1. **load_linked** &x -> Reg
2. add Reg, 1
3. store_conditional Reg -> &x

mov &x, 2

2. store 2 -> &x

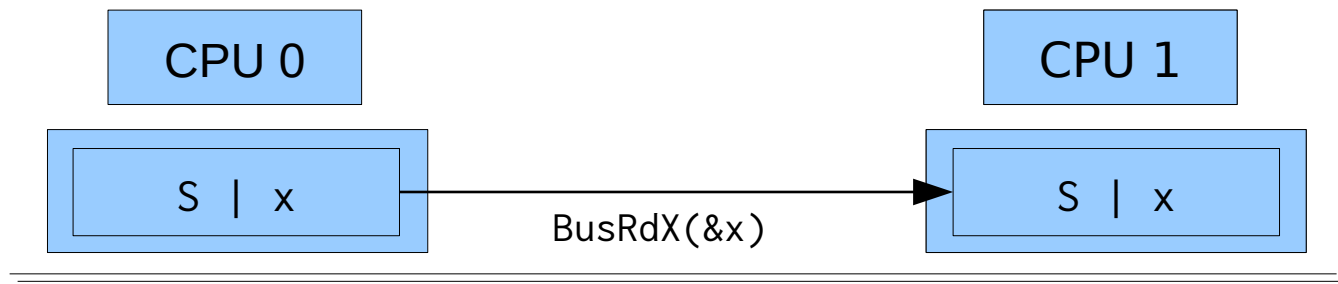

Atomic Hardware Instructions

How to make instructions atomic?

- Observe Cache

- Install cache watchdog on load
- Abort store if watchdog has detected a concurrent access; retry OP

add &x, 1

1. **load_linked** &x -> Reg
2. add Reg, 1
3. **store_conditional** Reg -> &x

mov &x, 2

2. store 2 -> &x

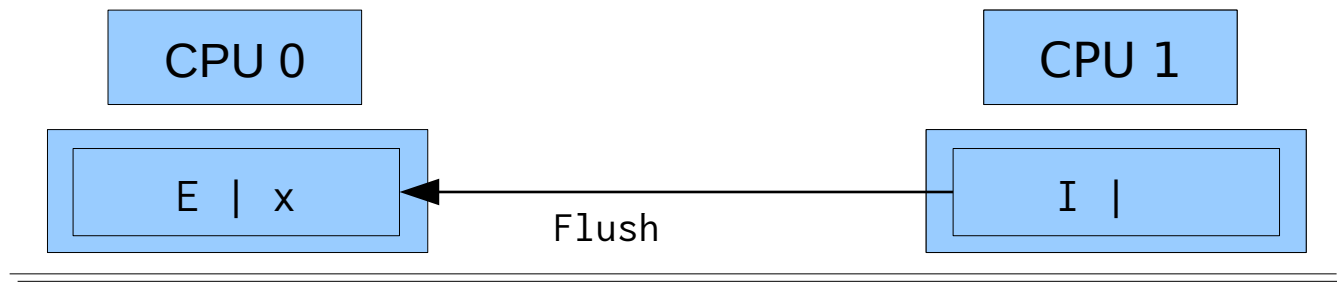

Atomic Hardware Instructions

How to make instructions atomic?

- Observe Cache

- Install cache watchdog on load
- Abort store if watchdog has detected a concurrent access; retry OP

add &x, 1

- load_linked &x -> Reg
- add Reg, 1**
- store_conditional Reg -> &x

mov &x, 2

- store 2 -> &x**

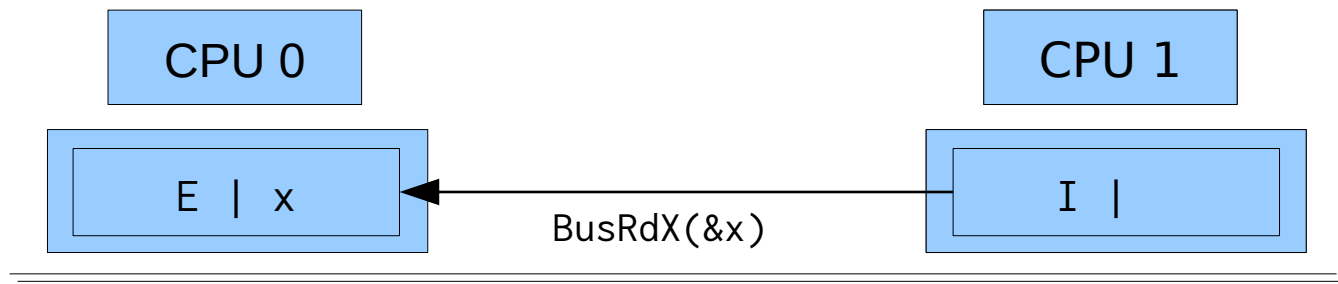

Atomic Hardware Instructions

How to make instructions atomic?

- Observe Cache

- Install cache watchdog on load
- Abort store if watchdog has detected a concurrent access; retry OP

add &x, 1

1. load_linked &x -> Reg
2. **add Reg, 1**
3. store_conditional Reg -> &x

mov &x, 2

2. **store 2 -> &x**

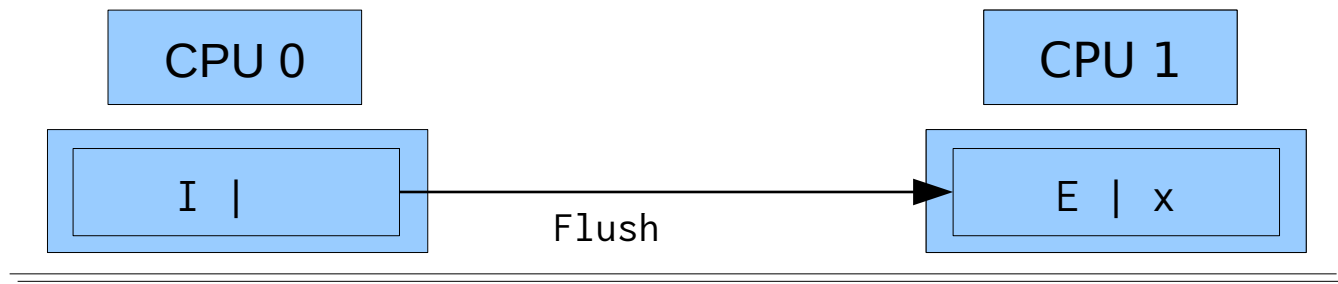

Atomic Hardware Instructions

How to make instructions atomic?

- Observe Cache

- Install cache watchdog on load
- Abort store if watchdog has detected a concurrent access; retry OP

add &x, 1

- load_linked &x -> Reg
- add Reg, 1
- store_conditional** Reg -> &x

→ **Abort**

mov &x, 2

- store 2 -> &x



Atomic Hardware Instructions

- Bit Test and Set

```
bit_test_and_set (bit) {  
    if (bit clear) {  
        set bit ; return true;  
    } else { return false; }  
}
```

- Exchange

```
swap (mem, Reg) {  
    mov &mem, tmp;  
    mov Reg, &mem;  
    mov tmp, Reg;  
}
```

- Fetch and Add

```
xadd (mem, Reg) {  
    mov &mem, tmp;  
    add &mem, Reg;  
    return tmp;  
}
```

Atomic Hardware Instructions

- Compare and Swap

```
cas (mem, expected, desired) {  
    if (&mem == expected) {  
        mov desired, &mem; return true;  
    } else { return false; }  
}
```

- Double Compare and Swap

```
cas (mem1, mem2, exp1, exp2, des1, des2) {  
    if (&mem1 == exp1 && &mem2 == exp2) {  
        mov des1, &mem1;  
        mov des2, &mem2;  
        return true;  
    } else { return false; }  
}
```

Overview

- Introduction
- Hardware Primitives
- Synchronization with Locks (Part I)
 - Properties
 - Locks
 - Spin Lock (Test & Set Lock)
 - Test & Test & Set Lock
 - Ticket Lock
- Synchronization without Locks
- Synchronization with Locks (Part II)
 - MCS Lock
 - Performance
 - Special Issues
 - Timeouts
 - Reader Writer Lock
 - Lockholder Preemption
 - Monitor, Mwait

Synchronization w/ Locks

Properties

- Overhead
 - Taking a lock should be cheap (<10% of CS)
 - Minimize overhead if lock is currently free
- Fairness
 - Every thread should be able to obtain the lock after a finite amount of time
- Abort lock()-operations
 - Abort locking after a specified timeout
 - Stop threads which are currently waiting for a lock
- Concurrent access to CS
 - Support that multiple threads can enter the lock at the same time

Synchronization w/ Locks

Properties

- Lock-holder preemption
 - Preemption of the thread currently executing the CS
- Priority inversion
 - Prevent higher priority thread from executing because of lower priority thread holding shared lock
 - **Not covered in this lecture!** (See MKC or RTS)
- Spinning vs. Blocking
 - Release CPU while waiting for the lock to be free again
 - Latency and performance implications

Synchronization w/ Locks

Spin Lock (Test & Set Lock)

```
void lock (lock_t *l) {
    do {
        int tmp = 1;
        swap (l->lock, tmp);
    } while (tmp == 1);
}

void unlock (lock_t *l) {
    l->lock = 0;
}
```

- + only one cheap atomic OP required
- high cache bus traffic while lock is held:

Synchronization w/ Locks

Spin Lock (Test & Set Lock)

```
void lock (lock_t *l) {  
    do {  
        int tmp = 1;  
        swap (l->lock, tmp);  
    } while (tmp == 1);  
}  
  
void unlock (lock_t *l) {  
    l->lock = 0;  
}
```

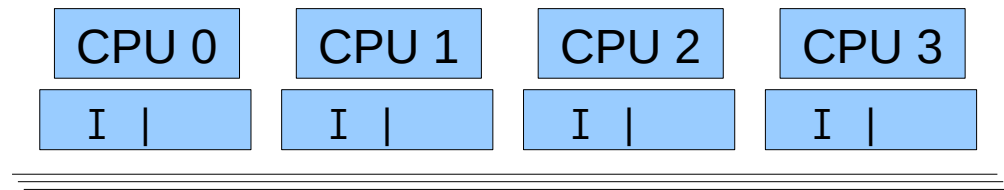

- + only one cheap atomic OP required
- high cache bus traffic while lock is held

Synchronization w/ Locks

Spin Lock (Test & Set Lock)

```
void lock (lock_t *l) {  
    do {  
        int tmp = 1;  
        swap (l->lock, tmp);  
    } while (tmp == 1);  
}  
  
void unlock (lock_t *l) {  
    l->lock = 0  
}
```

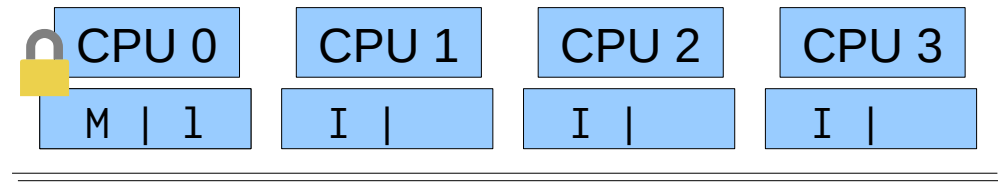

- + only one cheap atomic OP required
- high cache bus traffic while lock is held

Synchronization w/ Locks

Spin Lock (Test & Set Lock)

```
void lock (lock_t *l) {  
    do {  
        int tmp = 1;  
        swap (l->lock, tmp);  
    } while (tmp == 1);  
}  
  
void unlock (lock_t *l) {  
    l->lock = 0  
}
```

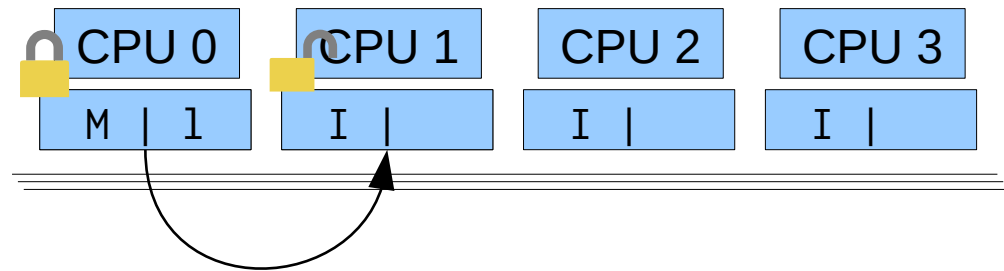

- + only one cheap atomic OP required
- high cache bus traffic while lock is held

Synchronization w/ Locks

Spin Lock (Test & Set Lock)

```
void lock (lock_t *l) {  
    do {  
        int tmp = 1;  
        swap (l->lock, tmp);  
    } while (tmp == 1);  
}  
  
void unlock (lock_t *l) {  
    l->lock = 0  
}
```

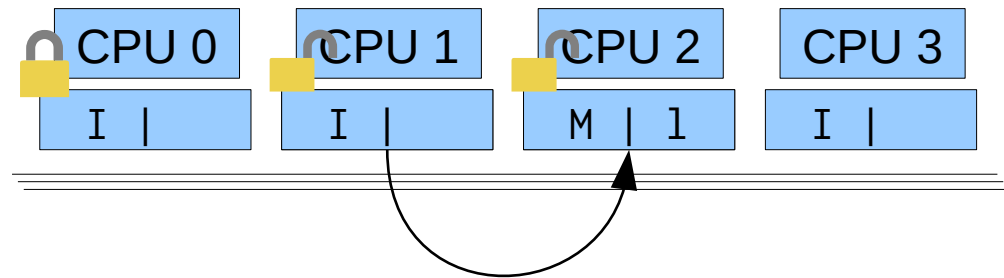

- + only one cheap atomic OP required
- high cache bus traffic while lock is held

Synchronization w/ Locks

Spin Lock (Test & Set Lock)

```
void lock (lock_t *l) {  
    do {  
        int tmp = 1;  
        swap (l->lock, tmp);  
    } while (tmp == 1);  
}
```

```
void unlock (lock_t *l) {  
    l->lock = 0;  
}
```

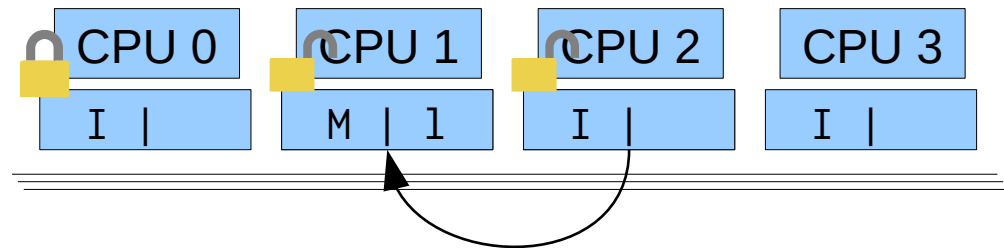

- + only one cheap atomic OP required
- high cache bus traffic while lock is held

Synchronization w/ Locks

Spin Lock (Test & Set Lock)

```
void lock (lock_t *l) {  
    do {  
        int tmp = 1;  
        swap (l->lock, tmp);  
    } while (tmp == 1);  
}
```

```
void unlock (lock_t *l) {  
    l->lock = 0;  
}
```

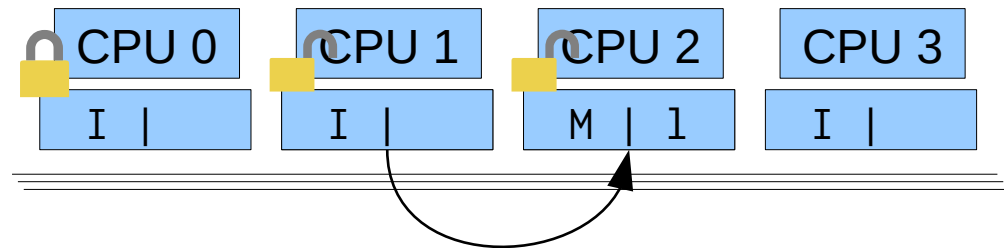

- + only one cheap atomic OP required
- high cache bus traffic while lock is held

Synchronization w/ Locks

Spin Lock (Test & Test & Set Lock)

```
void lock (lock_t *l) {
    do {
        int tmp = 1;
        do {} while (l->lock == 1);
        swap (l->lock, tmp);
    } while (tmp == 1);
}

void unlock (lock_t *l) {
    l->lock = 0;
}
```

- + spins locally while lock is held by other CPU
- + like Test & Set Lock but with fewer cache bus traffic

Synchronization w/ Locks

Spin Lock (Test & Test & Set Lock)

```
void lock (lock_t *l) {  
    do {  
        int tmp = 1;  
        do {} while (l->lock == 1);  
        swap (l->lock, tmp);  
    } while (tmp == 1);  
}  
  
void unlock (lock_t *l) {  
    l->lock = 0;  
}
```

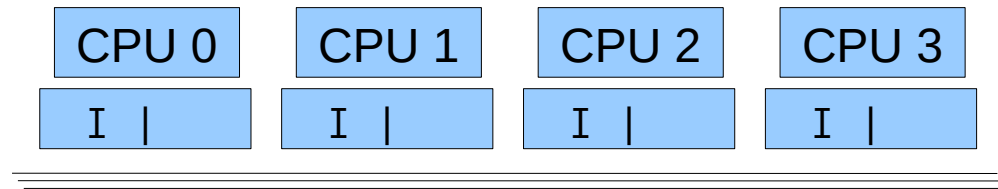

- + spins locally while lock is held by other CPU
- + like Test & Set Lock but with fewer cache bus traffic

Synchronization w/ Locks

Spin Lock (Test & Test & Set Lock)

```
void lock (lock_t *l) {  
    do {  
        int tmp = 1;  
        do {} while (l->lock == 1);  
        swap (l->lock, tmp);  
    } while (tmp == 1);  
}  
  
void unlock (lock_t *l) {  
    l->lock = 0;  
}
```

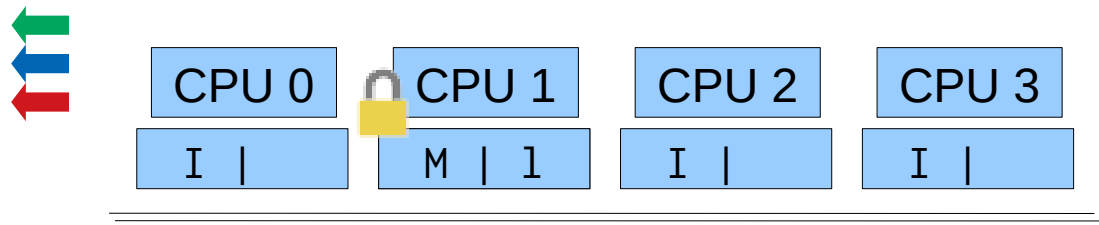

- + spins locally while lock is held by other CPU
- + like Test & Set Lock but with fewer cache bus traffic

Synchronization w/ Locks

Spin Lock (Test & Test & Set Lock)

```
void lock (lock_t *l) {  
    do {  
        int tmp = 1;  
        do {} while (l->lock == 1);  
        swap (l->lock, tmp);  
    } while (tmp == 1);  
}  
  
void unlock (lock_t *l) {  
    l->lock = 0  
}
```

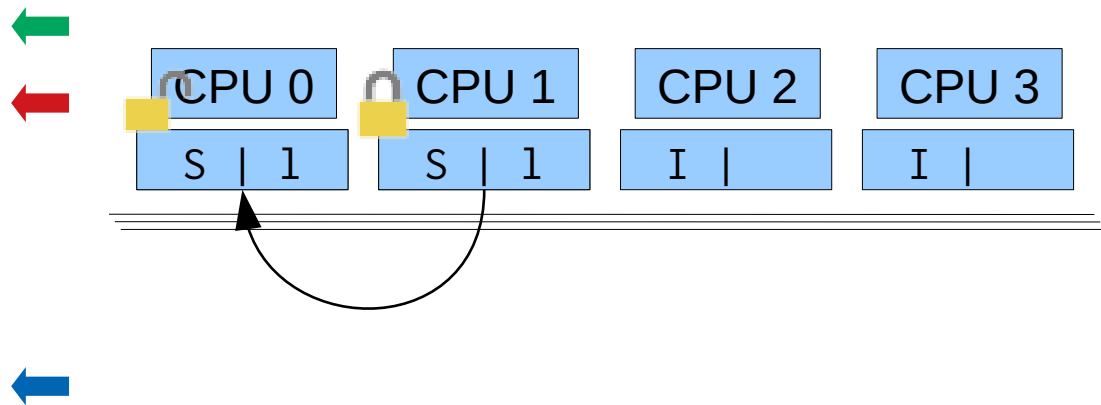

- + spins locally while lock is held by other CPU
- + like Test & Set Lock but with fewer cache bus traffic

Synchronization w/ Locks

Spin Lock (Test & Test & Set Lock)

```
void lock (lock_t *l) {  
    do {  
        int tmp = 1;  
        do {} while (l->lock == 1);  
        swap (l->lock, tmp);  
    } while (tmp == 1);  
}  
  
void unlock (lock_t *l) {  
    l->lock = 0  
}
```

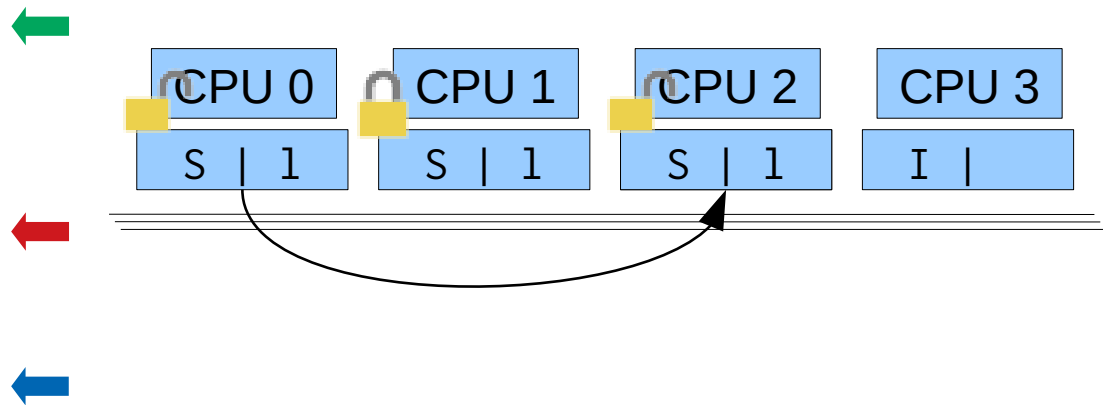

- + spins locally while lock is held by other CPU
- + like Test & Set Lock but with fewer cache bus traffic

Synchronization w/ Locks

Spin Lock (Test & Test & Set Lock)

```
void lock (lock_t *l) {  
    do {  
        int tmp = 1;  
        do {} while (l->lock == 1);  
        swap (l->lock, tmp);  
    } while (tmp == 1);  
}  
  
void unlock (lock_t *l) {  
    l->lock = 0;  
}
```

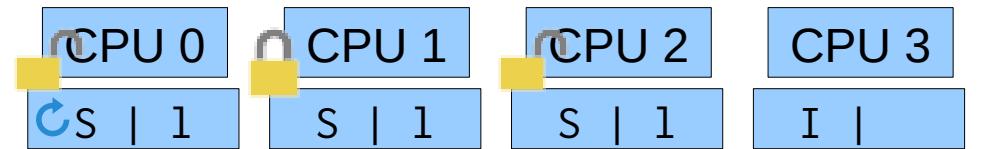

- + spins locally while lock is held by other CPU
- + like Test & Set Lock but with fewer cache bus traffic

Synchronization w/ Locks

Spin Lock (Test & Test & Set Lock)

```
void lock (lock_t *l) {  
    do {  
        int tmp = 1;  
        do {} while (l->lock == 1);  
        swap (l->lock, tmp);  
    } while (tmp == 1);  
}  
  
void unlock (lock_t *l) {  
    l->lock = 0;  
}
```

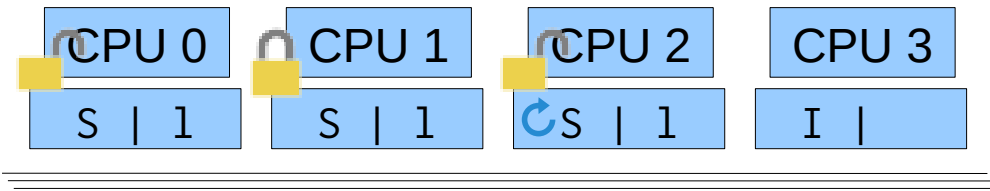

- + spins locally while lock is held by other CPU
- + like Test & Set Lock but with fewer cache bus traffic

Synchronizatio w/ Locks

Fairness – Test & Set Locks

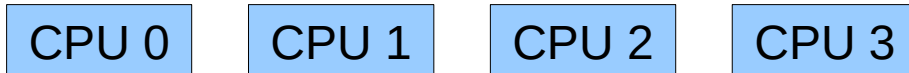

Synchronizatio w/ Locks

Fairness – Test & Set Locks

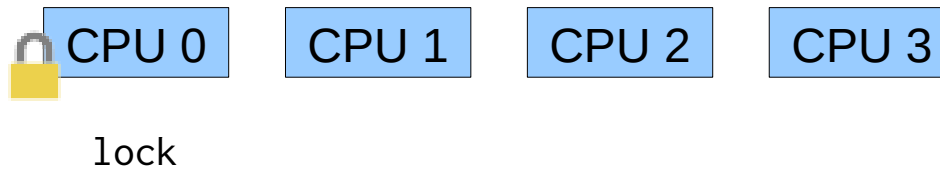

Synchronizatio w/ Locks

Fairness – Test & Set Locks

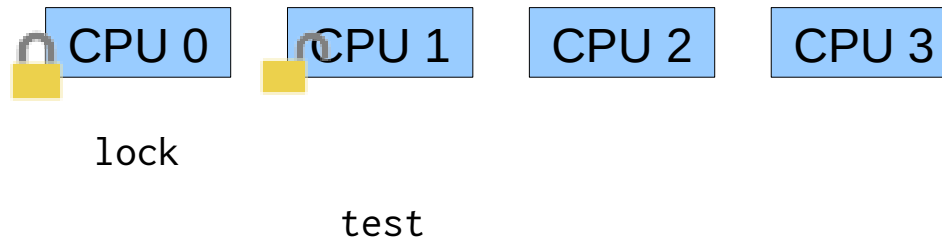

Synchronizatio w/ Locks

Fairness – Test & Set Locks

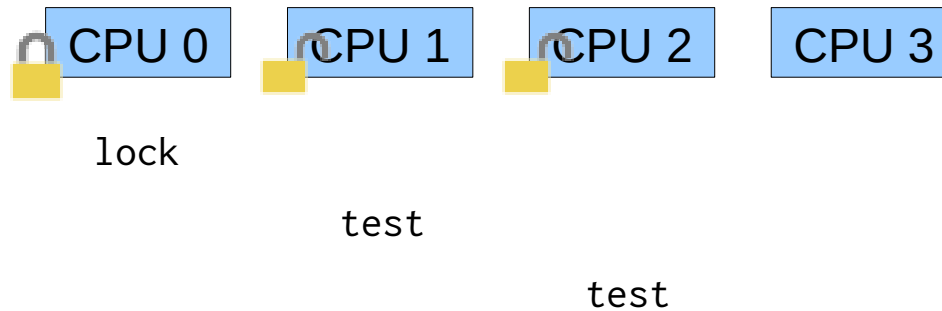

Synchronizatio w/ Locks

Fairness – Test & Set Locks

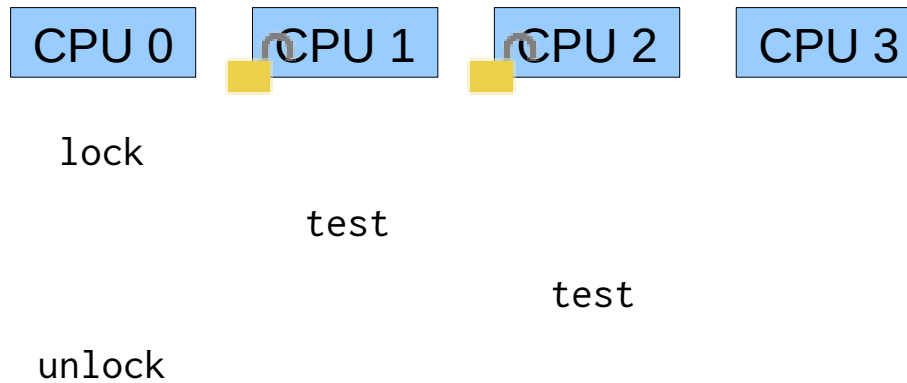

Synchronizatio w/ Locks

Fairness – Test & Set Locks

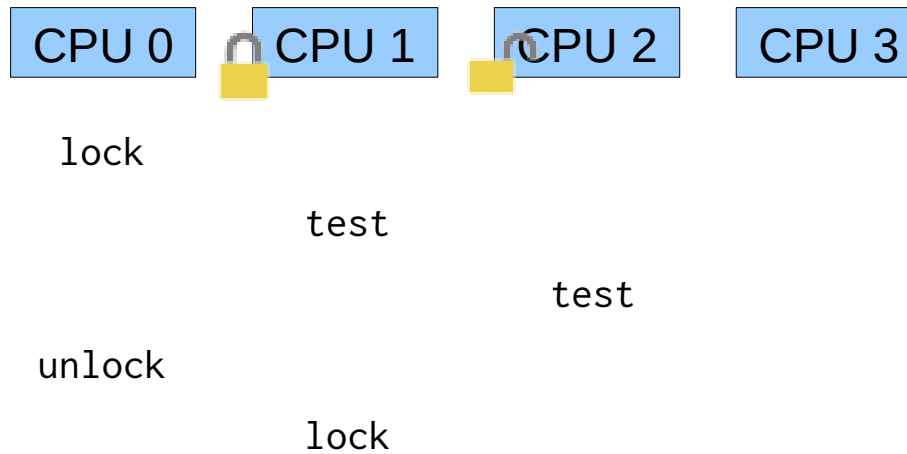

Synchronizatio w/ Locks

Fairness – Test & Set Locks

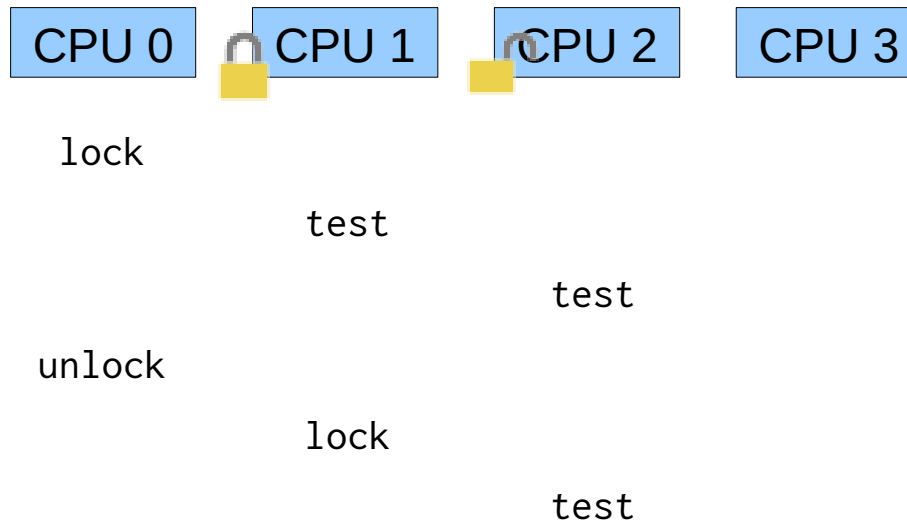

Synchronizatio w/ Locks

Fairness – Test & Set Locks

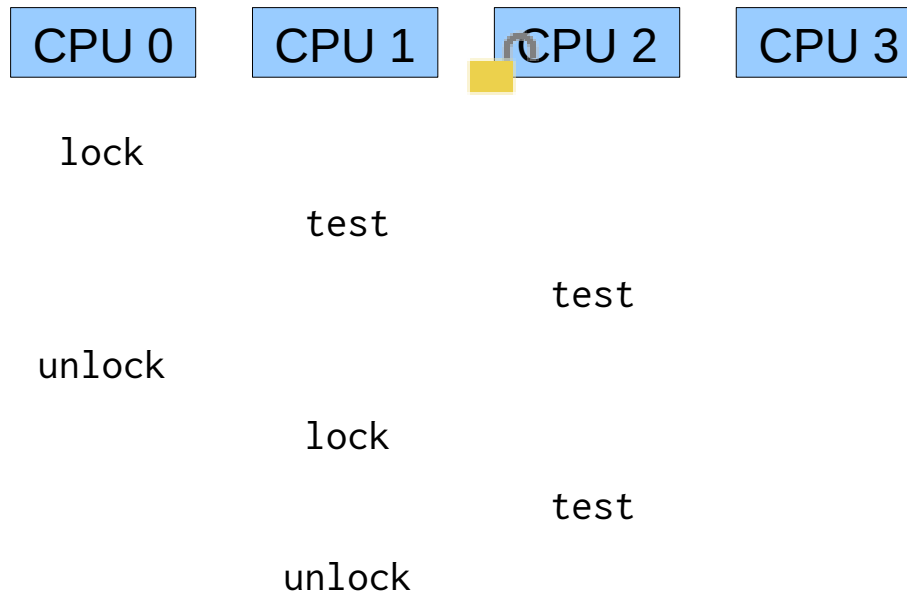

Synchronizatio w/ Locks

Fairness – Test & Set Locks

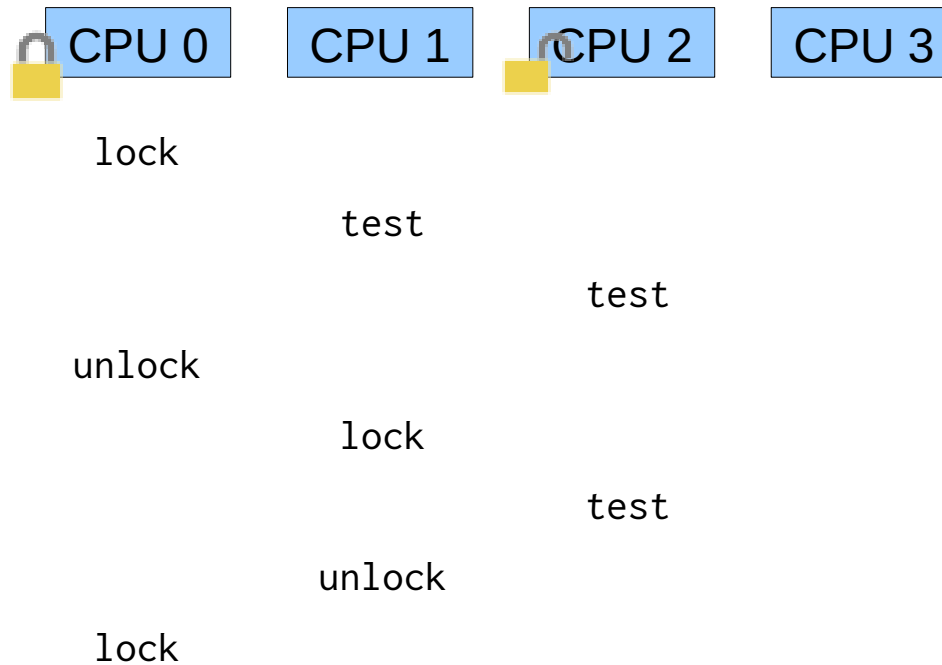

Synchronizatio w/ Locks

Fairness – Test & Set Locks

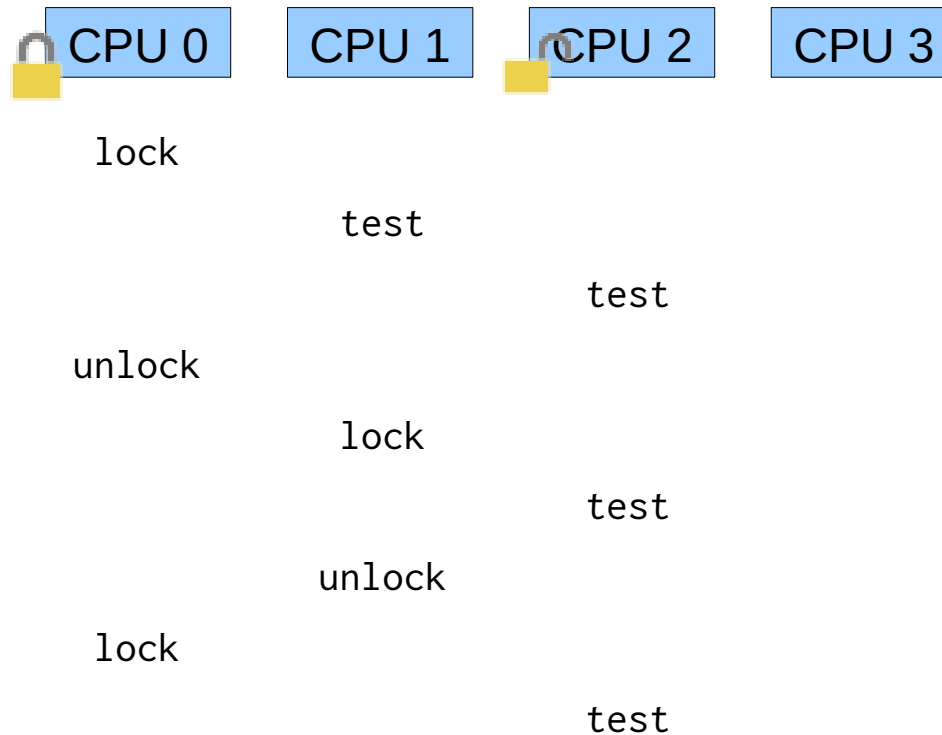

Synchronizatio w/ Locks

Fairness – Test & Set Locks

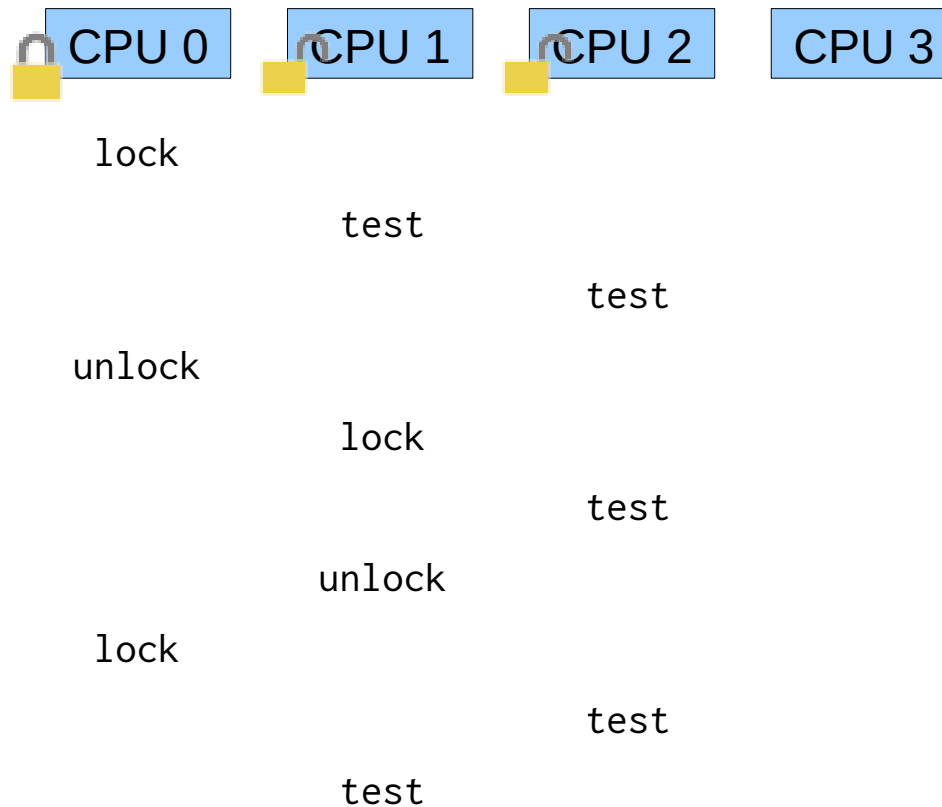

Synchronizatio w/ Locks

Fairness – Test & Set Locks

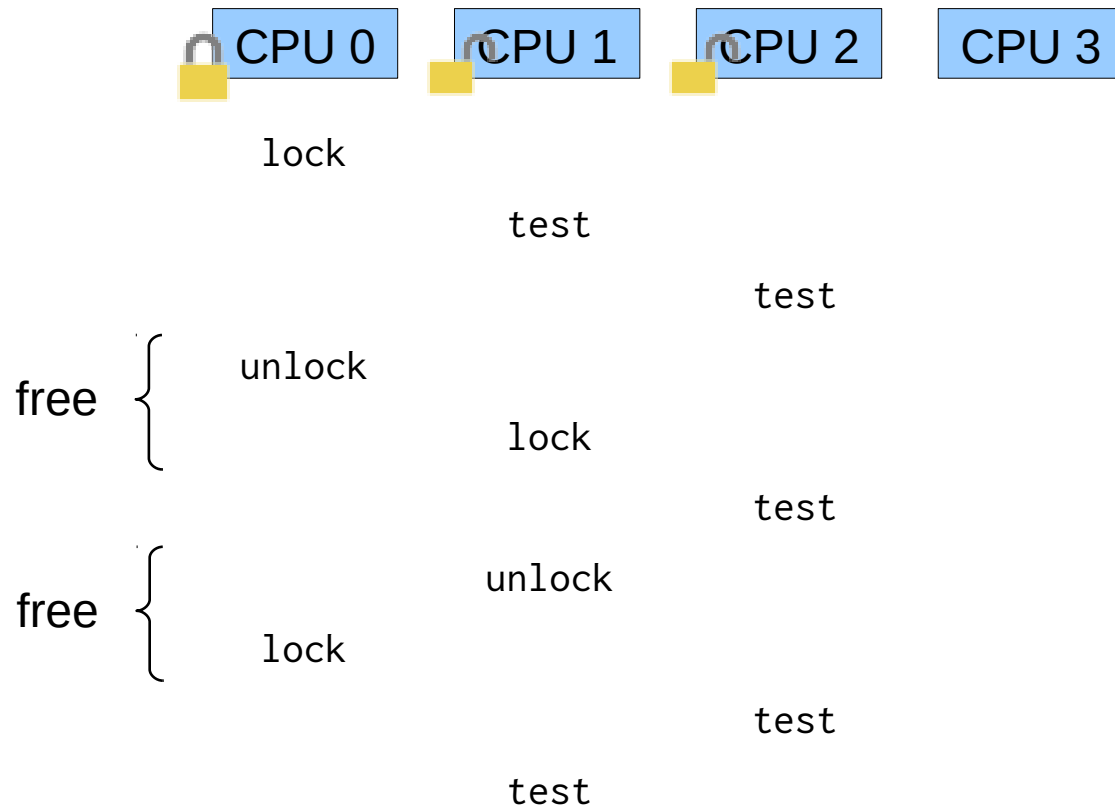

Although the lock was free multiple times CPU2 did not get it.

→ Test & Set Locks are not fair!

Synchronization w/ Locks

Ticket Locks

```
struct ticket_lock_t {
    int next_ticket;
    volatile int cur_ticket;
};

void lock (ticket_lock_t *l) {
    int my_ticket = xadd(&(l->next_ticket), 1);
    do {} while (l->cur_ticket != my_ticket);
}

void unlock (ticket_lock_t *l) {
    l->cur_ticket++;
}
```

- + similarly cheap as Test & Set Lock
- + ensures fairness between threads

Synchronization w/ Locks

Ticket Locks

```
struct ticket_lock_t {
    int next_ticket;
    volatile int cur_ticket;
};

void lock (ticket_lock_t *l) {
    int my_ticket = xadd(&(l->next_ticket), 1);
    do {} while (l->cur_ticket != my_ticket);
}

void unlock (ticket_lock_t *l) {
    l->cur_ticket++;
}
```

CPU 0

CPU 1

CPU 2

```
my_ticket
next_ticket  0          cur_ticket  0
```

Synchronization w/ Locks

Ticket Locks

```
struct ticket_lock_t {  
    int next_ticket;  
    volatile int cur_ticket;  
};
```

```
void lock (ticket_lock_t *l) {  
    int my_ticket = xadd(&(l->next_ticket), 1);  
    do {} while (l->cur_ticket != my_ticket);  
}
```

```
void unlock (ticket_lock_t *l) {  
    l->cur_ticket++;  
}
```

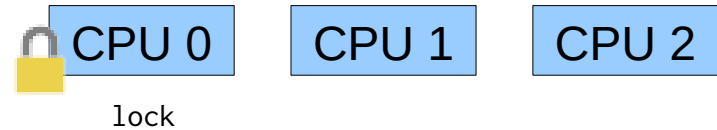

my_ticket	0		
next_ticket	1	cur_ticket	0

Synchronization w/ Locks

Ticket Locks

```
struct ticket_lock_t {  
    int next_ticket;  
    volatile int cur_ticket;  
};
```

```
void lock (ticket_lock_t *l) {  
    int my_ticket = xadd(&(l->next_ticket), 1);  
    do {} while (l->cur_ticket != my_ticket);  
}
```

```
void unlock (ticket_lock_t *l) {  
    l->cur_ticket++;  
}
```

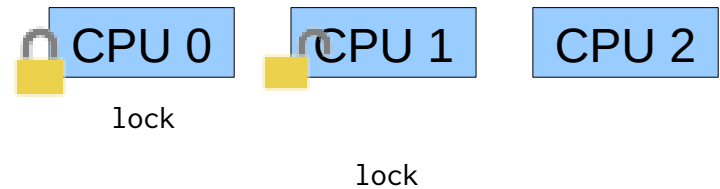

my_ticket	0	1	
next_ticket	2	cur_ticket	0

Synchronization w/ Locks

Ticket Locks

```
struct ticket_lock_t {  
    int next_ticket;  
    volatile int cur_ticket;  
};
```

```
void lock (ticket_lock_t *l) {  
    int my_ticket = xadd(&(l->next_ticket), 1);  
    do {} while (l->cur_ticket != my_ticket);  
}
```

```
void unlock (ticket_lock_t *l) {  
    l->cur_ticket++;  
}
```

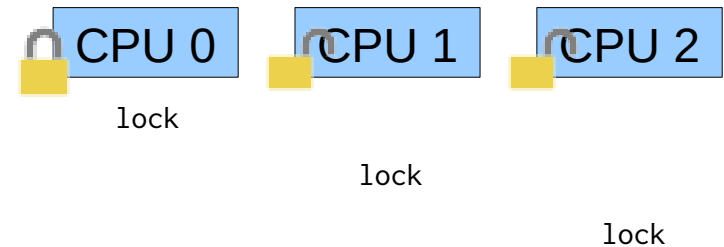

my_ticket	0	1	2
next_ticket	3	cur_ticket	0

Synchronization w/ Locks

Ticket Locks

```
struct ticket_lock_t {
    int next_ticket;
    volatile int cur_ticket;
};

void lock (ticket_lock_t *l) {
    int my_ticket = xadd(&l->next_ticket, 1);
    do {} while (l->cur_ticket != my_ticket);
}

void unlock (ticket_lock_t *l) {
    l->cur_ticket++;
}
```

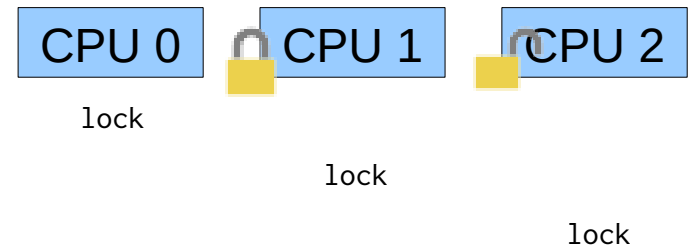

my_ticket		1	2
next_ticket	3	cur_ticket	1

Synchronization w/ Locks

Ticket Locks

```
struct ticket_lock_t {  
    int next_ticket;  
    volatile int cur_ticket;  
};
```

```
void lock (ticket_lock_t *l) {  
    int my_ticket = xadd(&(l->next_ticket), 1);  
    do {} while (l->cur_ticket != my_ticket);  
}
```

```
void unlock (ticket_lock_t *l) {  
    l->cur_ticket++;  
}
```

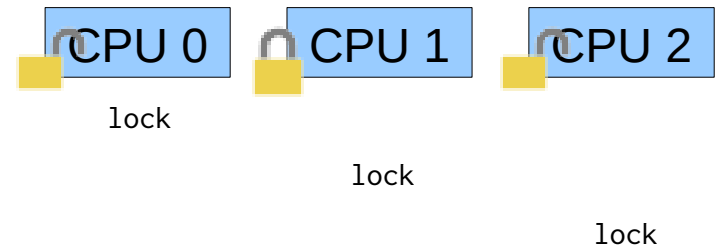

my_ticket	3	1	2
next_ticket	4	cur_ticket	1

Synchronization w/ Locks

Ticket Locks

```
struct ticket_lock_t {
    int next_ticket;
    volatile int cur_ticket;
};

void lock (ticket_lock_t *l) {
    int my_ticket = xadd(&(l->next_ticket), 1);
    do {} while (l->cur_ticket != my_ticket);
}

void unlock (ticket_lock_t *l) {
    l->cur_ticket++;
}
```

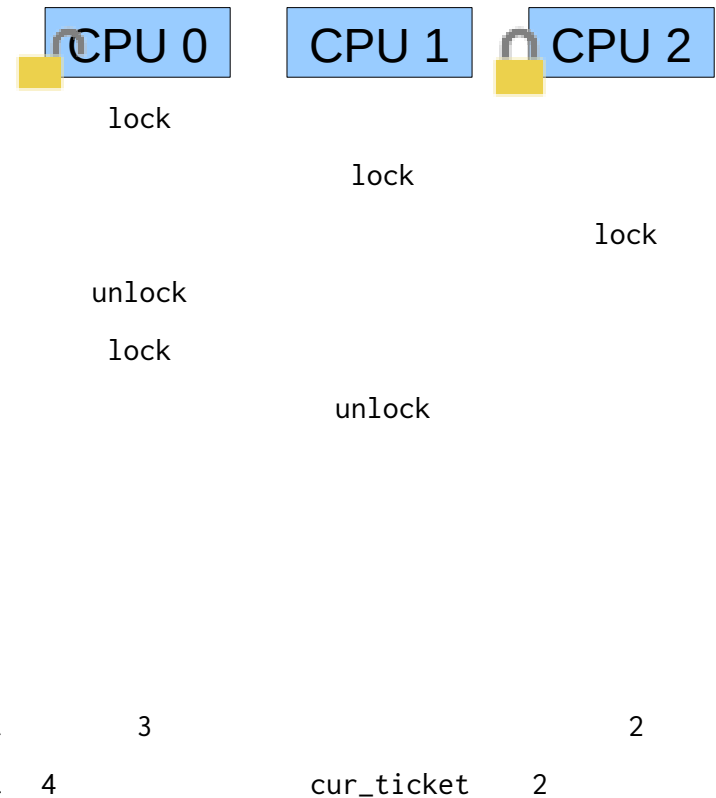

Synchronization w/ Locks

Ticket Locks

```
struct ticket_lock_t {
    int next_ticket;
    volatile int cur_ticket;
};

void lock (ticket_lock_t *l) {
    int my_ticket = xadd(&(l->next_ticket), 1);
    do {} while (l->cur_ticket != my_ticket);
}

void unlock (ticket_lock_t *l) {
    l->cur_ticket++;
}
```

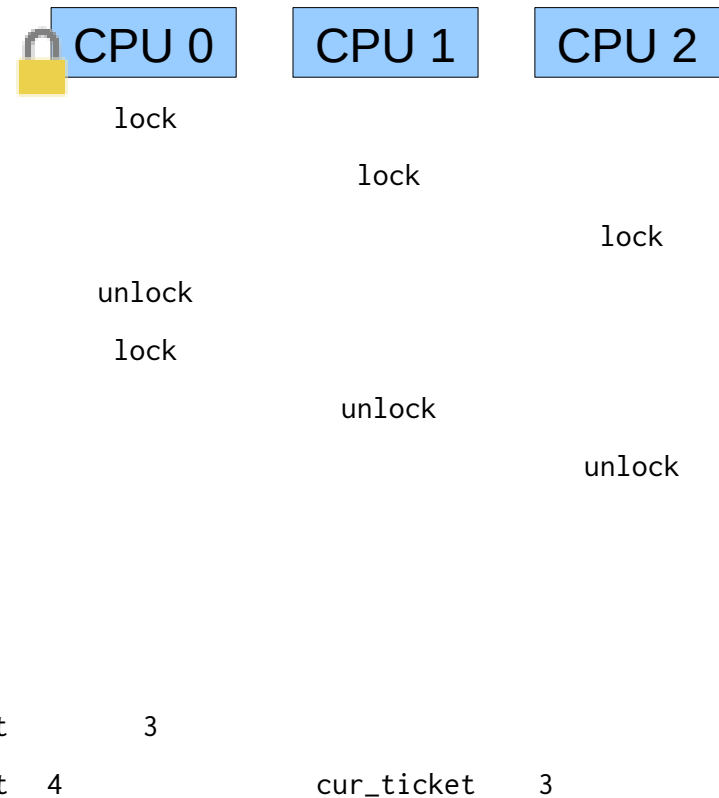

Synchronization w/ Locks

Ticket Locks

```
struct ticket_lock_t {
    int next_ticket;
    volatile int cur_ticket;
};

void lock (ticket_lock_t *l) {
    int my_ticket = xadd(&(l->next_ticket), 1);
    do {} while (l->cur_ticket != my_ticket);
}

void unlock (ticket_lock_t *l) {
    l->cur_ticket++;
}
```

- unnecessary bus traffic on ticket increase
- abort of lock operation is difficult to implement

Synchronization w/ Locks

Ticket Locks

```
struct ticket_lock_t {  
    int next_ticket;  
    volatile int cur_ticket;  
};
```

```
void lock (ticket_lock_t *l) {  
    int my_ticket = xadd(&(l->next_ticket), 1);  
    do {} while (l->cur_ticket != my_ticket);  
}
```

```
void unlock (ticket_lock_t *l) {  
    l->cur_ticket++;  
}
```



my_ticket	0	1	2
next_ticket	3	cur_ticket	0

- unnecessary bus traffic on ticket increase
- abort of lock operation is difficult to implement

Synchronization w/ Locks

Ticket Locks

```
struct ticket_lock_t {  
    int next_ticket;  
    volatile int cur_ticket;  
};
```

```
void lock (ticket_lock_t *l) {  
    int my_ticket = xadd(&(l->next_ticket), 1);  
    do {} while (l->cur_ticket != my_ticket);  
}
```

```
void unlock (ticket_lock_t *l) {  
    l->cur_ticket++;  
}
```

my_ticket	1	2
next_ticket	3	1

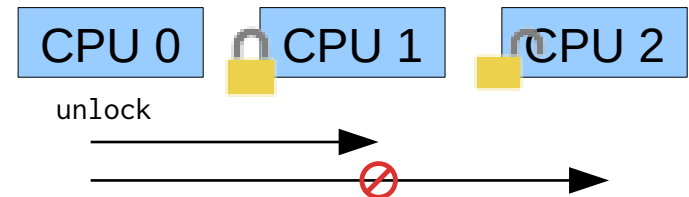

- unnecessary bus traffic on ticket increase
- abort of lock operation is difficult to implement

Overview

- Introduction
- Hardware Primitives
- Synchronization with Locks (Part I)
 - Properties
 - Locks
 - Spin Lock (Test & Set Lock)
 - Test & Test & Set Lock
 - Ticket Lock
- Synchronization without Locks
- Synchronization with Locks (Part II)
 - MCS Lock
 - Performance
 - Special Issues
 - Timeouts
 - Reader Writer Lock
 - Lockholder Preemption
 - Monitor, Mwait

Synchronization w/o Locks

Lock-free Data Structures

■ Single-Linked List

```
void insert(ele_t *new_ele, ele_t *prev) {  
    do {  
        new_ele->next = prev->next;  
    } while (!cas(&(prev->next), new_ele->next, new_ele));  
}
```

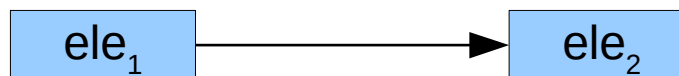

Synchronization w/o Locks

Lock-free Data Structures

■ Single-Linked List

```
void insert(ele_t *new_ele, ele_t *prev) {  
    do {  
        new_ele->next = prev->next;  
    } while (!cas(&(prev->next), new_ele->next, new_ele));  
}
```

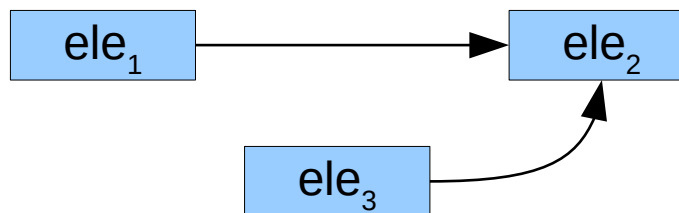

Synchronization w/o Locks

Lock-free Data Structures

■ Single-Linked List

```
void insert(ele_t *new_ele, ele_t *prev) {  
    do {  
        new_ele->next = prev->next;  
    } while (!cas(&(prev->next), new_ele->next, new_ele));  
}
```

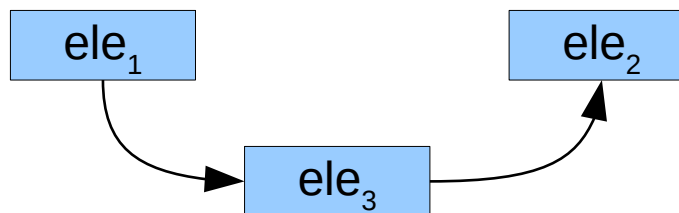

Synchronization w/o Locks

Lock-free Data Structures

- Single-Linked List

```
void insert(ele_t *new_ele, ele_t *prev) {  
    do {  
        load_linked(prev->next);  
        new_ele->next = prev->next  
    } while (!store_conditional(&(prev->next), new_ele));  
}
```

Synchronization w/o Locks

Lock-free Data Structures

- Single-Linked List
- Double-Linked List

```
void insert(ele_t *new_ele, ele_t *prev) {  
    do {  
        auto next = prev->next;  
        new_ele->next = next;  
        new_ele->prev = prev;  
    } while (!dcas(&(prev->next), &(next->prev),  
                 new_ele->next, new_ele->prev,  
                 new_ele, new_ele));  
}
```



Synchronization w/o Locks

Lock-free Data Structures

- Single-Linked List
- Double-Linked List

```
void insert(ele_t *new_ele, ele_t *prev) {  
    do {  
        auto next = prev->next;  
        new_ele->next = next;  
        new_ele->prev = prev;  
    } while (!dcas(&(prev->next), &(next->prev),  
                 new_ele->next, new_ele->prev,  
                 new_ele, new_ele));  
}
```

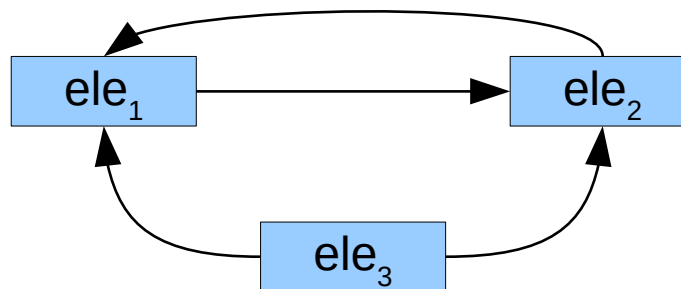

Synchronization w/o Locks

Lock-free Data Structures

- Single-Linked List
- Double-Linked List

```
void insert(ele_t *new_ele, ele_t *prev) {  
    do {  
        auto next = prev->next;  
        new_ele->next = next;  
        new_ele->prev = prev;  
    } while (!dcas(&(prev->next), &(next->prev),  
                 new_ele->next, new_ele->prev,  
                 new_ele, new_ele));  
}
```

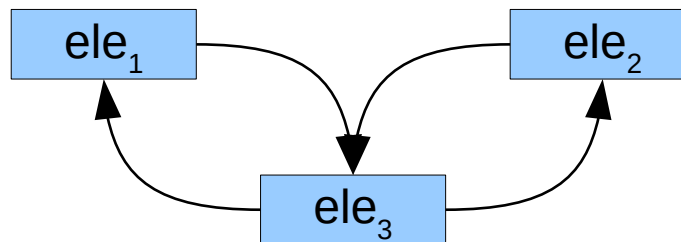

Synchronization w/o Locks

Lock-free Data Structures

- Single-Linked List
- Double-Linked List
- Binary Trees
- ...

Not using locks does not solve all problems of locks!

e.g. Fairness → Wait-free Data Structures

Overview

- Introduction
- Hardware Primitives
- Synchronization with Locks (Part I)
 - Properties
 - Locks
 - Spin Lock (Test & Set Lock)
 - Test & Test & Set Lock
 - Ticket Lock
- Synchronization without Locks
- Synchronization with Locks (Part II)
 - MCS Lock
 - Performance
 - Special Issues
 - Timeouts
 - Reader Writer Lock
 - Lockholder Preemption
 - Monitor, Mwait

Synchronization w/ Locks

MCS-Lock – fair local spinning lock – Mellor-Crummey and Scott

```
struct mcs_node_t {  
    mcs_node_t* next;  
    bool free;  
};  
  
struct mcs_lock_t {  
    mcs_node_t* queue;  
};
```

```
void mcs_lock(mcs_lock_t* l, mcs_node_t* cur) {  
    cur->next = NULL;  
    cur->free = false;  
    auto prev = fetch_and_store(&(l->queue), cur);  
    if (prev) {  
        prev->next = cur;  
        do {} while (!cur->free);  
    }  
}
```

```
void mcs_unlock(mcs_lock_t* l, mcs_node_t* cur) {  
    if (!cur->next) {  
        if (cas(&(l->queue), cur, NULL)) return;  
        do {} while (!cur->next);  
    }  
    cur->next->free = true;  
}
```



queue

Synchronization w/ Locks

MCS-Lock – fair local spinning lock – Mellor-Crummey and Scott

```
struct mcs_node_t {  
    mcs_node_t* next;  
    bool free;  
};  
  
struct mcs_lock_t {  
    mcs_node_t* queue;  
};
```

```
void mcs_lock(mcs_lock_t* l, mcs_node_t* cur) {  
    cur->next = NULL;  
    cur->free = false;  
    auto prev = fetch_and_store(&(l->queue), cur);  
    if (prev) {  
        prev->next = cur;  
        do {} while (!cur->free);  
    }  
}
```

```
void mcs_unlock(mcs_lock_t* l, mcs_node_t* cur) {  
    if (!cur->next) {  
        if (cas(&(l->queue), cur, NULL)) return;  
        do {} while (!cur->next);  
    }  
    cur->next->free = true;  
}
```

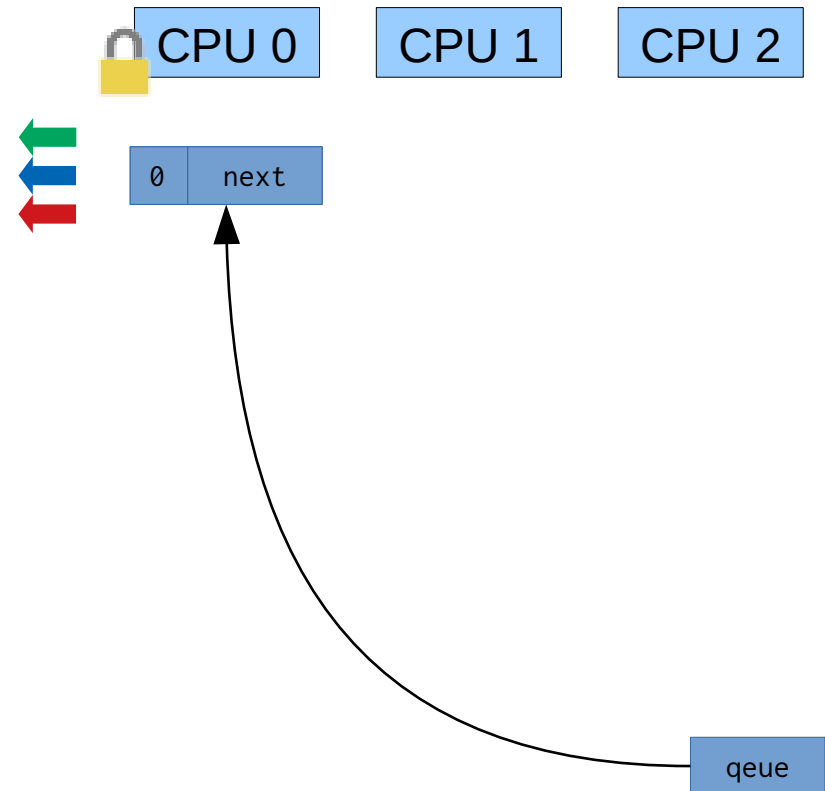

Synchronization w/ Locks

MCS-Lock – fair local spinning lock – Mellor-Crummey and Scott

```
struct mcs_node_t {  
    mcs_node_t* next;  
    bool free;  
};  
  
struct mcs_lock_t {  
    mcs_node_t* queue;  
};
```

```
void mcs_lock(mcs_lock_t* l, mcs_node_t* cur) {  
    cur->next = NULL;  
    cur->free = false;  
    auto prev = fetch_and_store(&(l->queue), cur);  
    if (prev) {  
        prev->next = cur;  
        do {} while (!cur->free);  
    }  
}
```

```
void mcs_unlock(mcs_lock_t* l, mcs_node_t* cur) {  
    if (!cur->next) {  
        if (cas(&(l->queue), cur, NULL)) return;  
        do {} while (!cur->next);  
    }  
    cur->next->free = true;  
}
```

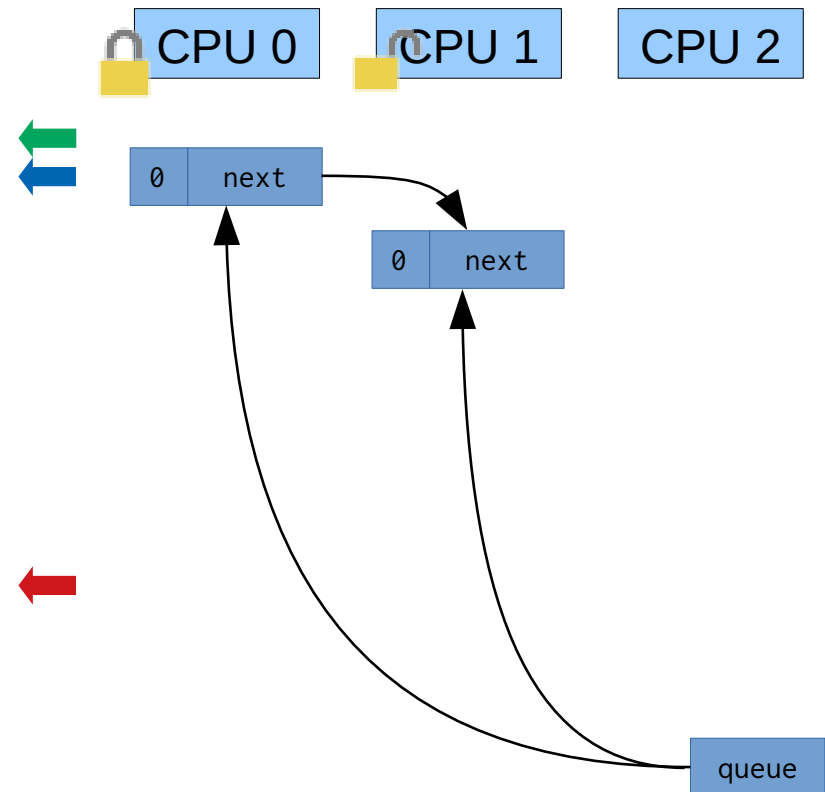

Synchronization w/ Locks

MCS-Lock – fair local spinning lock – Mellor-Crummey and Scott

```
struct mcs_node_t {  
    mcs_node_t* next;  
    bool free;  
};  
  
struct mcs_lock_t {  
    mcs_node_t* queue;  
};
```

```
void mcs_lock(mcs_lock_t* l, mcs_node_t* cur) {  
    cur->next = NULL;  
    cur->free = false;  
    auto prev = fetch_and_store(&(l->queue), cur);  
    if (prev) {  
        prev->next = cur;  
        do {} while (!cur->free);  
    }  
}
```

```
void mcs_unlock(mcs_lock_t* l, mcs_node_t* cur) {  
    if (!cur->next) {  
        if (cas(&(l->queue), cur, NULL)) return;  
        do {} while (!cur->next);  
    }  
    cur->next->free = true;  
}
```

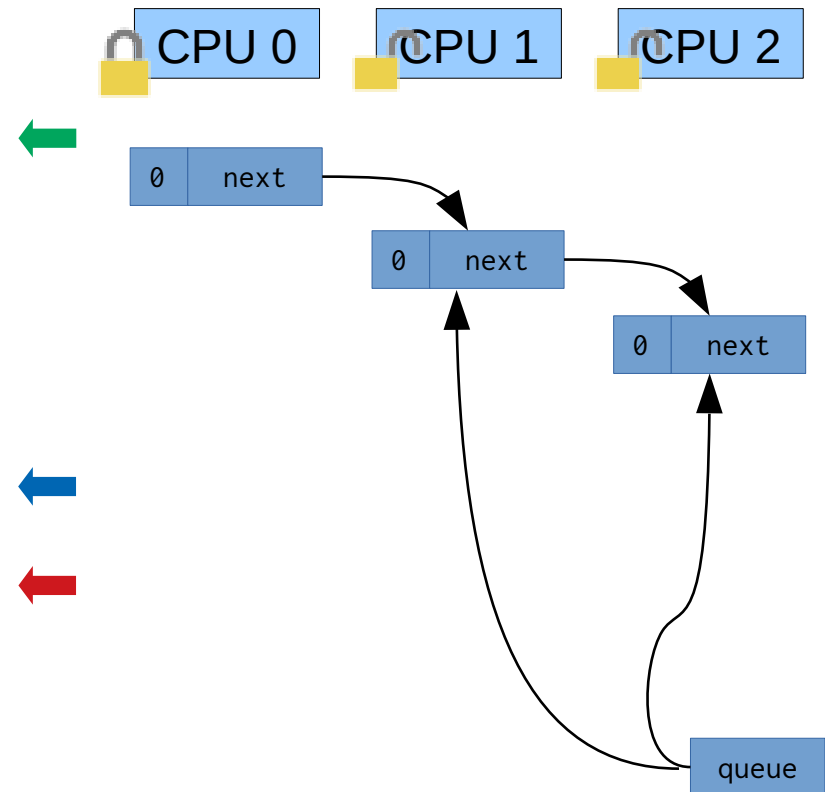

Synchronization w/ Locks

MCS-Lock – fair local spinning lock – Mellor-Crummey and Scott

```
struct mcs_node_t {  
    mcs_node_t* next;  
    bool free;  
};  
  
struct mcs_lock_t {  
    mcs_node_t* queue;  
};
```

```
void mcs_lock(mcs_lock_t* l, mcs_node_t* cur) {  
    cur->next = NULL;  
    cur->free = false;  
    auto prev = fetch_and_store(&(l->queue), cur);  
    if (prev) {  
        prev->next = cur;  
        do {} while (!cur->free);  
    }  
}
```

```
void mcs_unlock(mcs_lock_t* l, mcs_node_t* cur) {  
    if (!cur->next) {  
        if (cas(&(l->queue), cur, NULL)) return;  
        do {} while (!cur->next);  
    }  
    cur->next->free = true;  
}
```

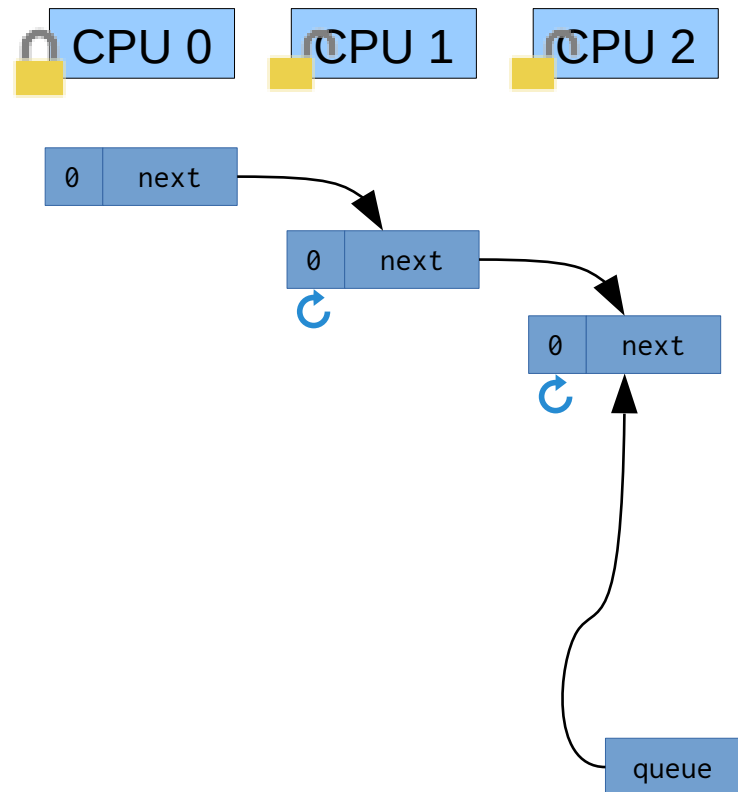

Synchronization w/ Locks

MCS-Lock – fair local spinning lock – Mellor-Crummey and Scott

```
struct mcs_node_t {  
    mcs_node_t* next;  
    bool free;  
};  
  
struct mcs_lock_t {  
    mcs_node_t* queue;  
};
```

```
void mcs_lock(mcs_lock_t* l, mcs_node_t* cur) {  
    cur->next = NULL;  
    cur->free = false;  
    auto prev = fetch_and_store(&(l->queue), cur);  
    if (prev) {  
        prev->next = cur;  
        do {} while (!cur->free);  
    }  
}
```

```
void mcs_unlock(mcs_lock_t* l, mcs_node_t* cur) {  
    if (!cur->next) {  
        if (cas(&(l->queue), cur, NULL)) return;  
        do {} while (!cur->next);  
    }  
    cur->next->free = true;  
}
```

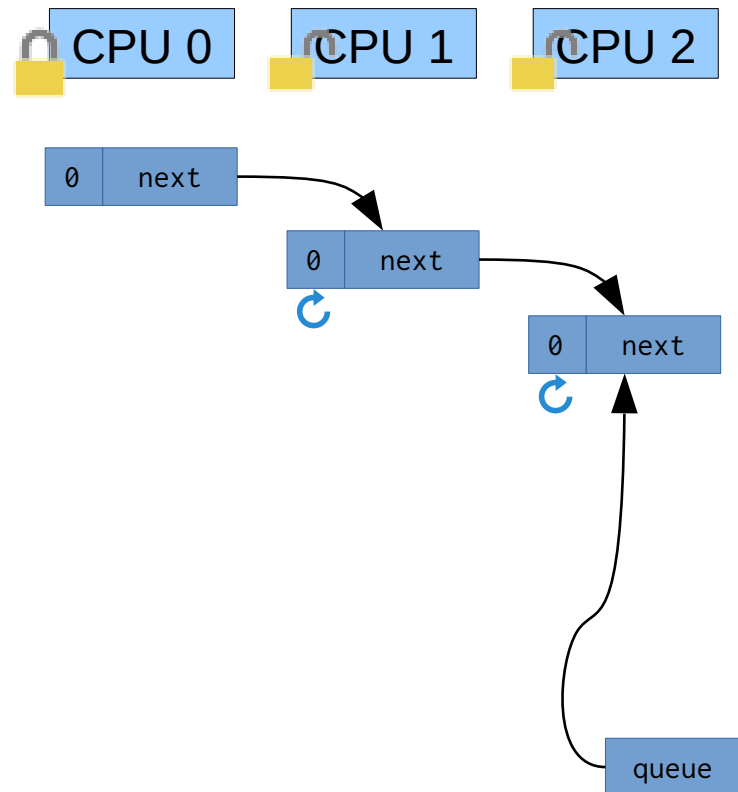

Synchronization w/ Locks

MCS-Lock – fair local spinning lock – Mellor-Crummey and Scott

```
struct mcs_node_t {  
    mcs_node_t* next;  
    bool free;  
};  
  
struct mcs_lock_t {  
    mcs_node_t* queue;  
};
```

```
void mcs_lock(mcs_lock_t* l, mcs_node_t* cur) {  
    cur->next = NULL;  
    cur->free = false;  
    auto prev = fetch_and_store(&(l->queue), cur);  
    if (prev) {  
        prev->next = cur;  
        do {} while (!cur->free);  
    }  
}
```

```
void mcs_unlock(mcs_lock_t* l, mcs_node_t* cur) {  
    if (!cur->next) {  
        if (cas(&(l->queue), cur, NULL)) return;  
        do {} while (!cur->next);  
    }  
    cur->next->free = true;  
}
```

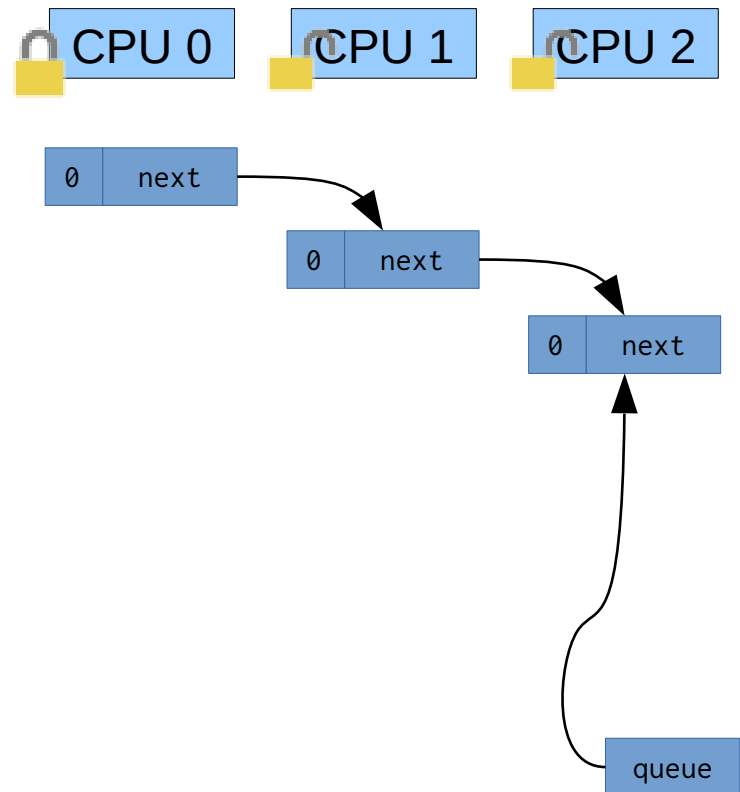

Synchronization w/ Locks

MCS-Lock – fair local spinning lock – Mellor-Crummey and Scott

```
struct mcs_node_t {  
    mcs_node_t* next;  
    bool free;  
};  
  
struct mcs_lock_t {  
    mcs_node_t* queue;  
};
```

```
void mcs_lock(mcs_lock_t* l, mcs_node_t* cur) {  
    cur->next = NULL;  
    cur->free = false;  
    auto prev = fetch_and_store(&(l->queue), cur);  
    if (prev) {  
        prev->next = cur;  
        do {} while (!cur->free);  
    }  
}
```

```
void mcs_unlock(mcs_lock_t* l, mcs_node_t* cur) {  
    if (!cur->next) {  
        if (cas(&(l->queue), cur, NULL)) return;  
        do {} while (!cur->next);  
    }  
    cur->next->free = true;  
}
```

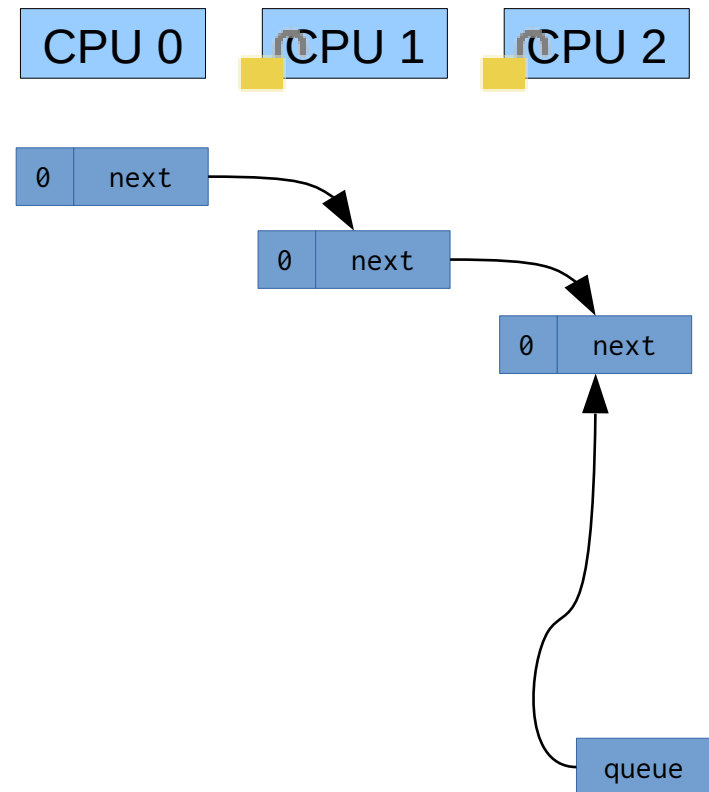

Synchronization w/ Locks

MCS-Lock – fair local spinning lock – Mellor-Crummey and Scott

```
struct mcs_node_t {  
    mcs_node_t* next;  
    bool free;  
};  
  
struct mcs_lock_t {  
    mcs_node_t* queue;  
};
```

```
void mcs_lock(mcs_lock_t* l, mcs_node_t* cur) {  
    cur->next = NULL;  
    cur->free = false;  
    auto prev = fetch_and_store(&(l->queue), cur);  
    if (prev) {  
        prev->next = cur;  
        do {} while (!cur->free);  
    }  
}
```

```
void mcs_unlock(mcs_lock_t* l, mcs_node_t* cur) {  
    if (!cur->next) {  
        if (cas(&(l->queue), cur, NULL)) return;  
        do {} while (!cur->next);  
    }  
    cur->next->free = true;  
}
```

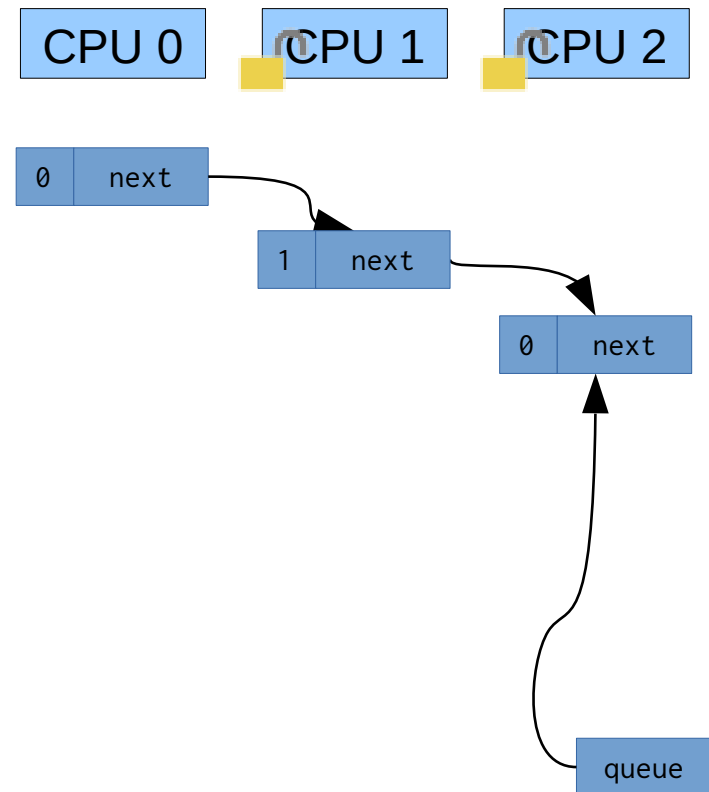

Synchronization w/ Locks

MCS-Lock – fair local spinning lock – Mellor-Crummey and Scott

```
struct mcs_node_t {
    mcs_node_t* next;
    bool free;
};

struct mcs_lock_t {
    mcs_node_t* queue;
};
```

```
void mcs_lock(mcs_lock_t* l, mcs_node_t* cur) {
    cur->next = NULL;
    cur->free = false;
    auto prev = fetch_and_store(&(l->queue), cur);
    if (prev) {
        prev->next = cur;
        do {} while (!cur->free);
    }
}
```

```
void mcs_unlock(mcs_lock_t* l, mcs_node_t* cur) {
    if (!cur->next) {
        if (cas(&(l->queue), cur, NULL)) return;
        do {} while (!cur->next);
    }
    cur->next->free = true;
}
```

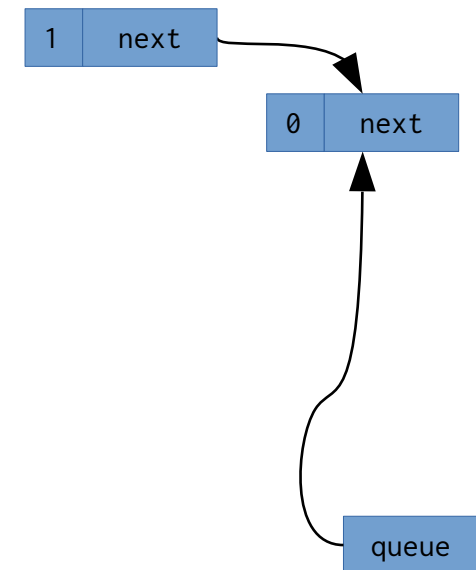
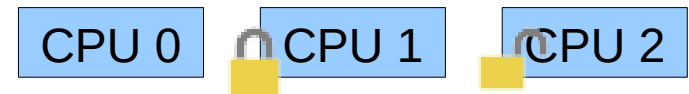

Synchronization w/ Locks

MCS-Lock – fair local spinning lock – Mellor-Crummey and Scott

```
struct mcs_node_t {
    mcs_node_t* next;
    bool free;
};

struct mcs_lock_t {
    mcs_node_t* queue;
};
```

```
void mcs_lock(mcs_lock_t* l, mcs_node_t* cur) {
    cur->next = NULL;
    cur->free = false;
    auto prev = fetch_and_store(&(l->queue), cur);
    if (prev) {
        prev->next = cur;
        do {} while (!cur->free);
    }
}
```

```
void mcs_unlock(mcs_lock_t* l, mcs_node_t* cur) {
    if (!cur->next) {
        if (cas(&(l->queue), cur, NULL)) return;
        do {} while (!cur->next);
    }
    cur->next->free = true;
}
```

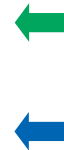
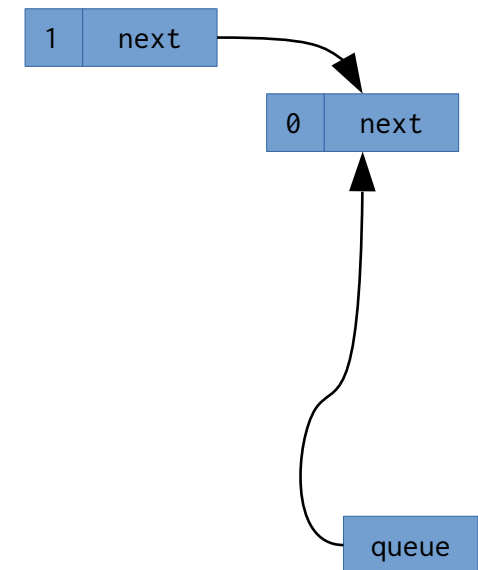
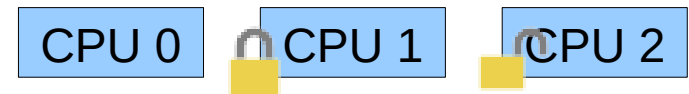

Synchronization w/ Locks

MCS-Lock – fair local spinning lock – Mellor-Crummey and Scott

```
struct mcs_node_t {  
    mcs_node_t* next;  
    bool free;  
};  
  
struct mcs_lock_t {  
    mcs_node_t* queue;  
};
```

```
void mcs_lock(mcs_lock_t* l, mcs_node_t* cur) {  
    cur->next = NULL;  
    cur->free = false;  
    auto prev = fetch_and_store(&(l->queue), cur);  
    if (prev) {  
        prev->next = cur;  
        do {} while (!cur->free);  
    }  
}
```

```
void mcs_unlock(mcs_lock_t* l, mcs_node_t* cur) {  
    if (!cur->next) {  
        if (cas(&(l->queue), cur, NULL)) return;  
        do {} while (!cur->next);  
    }  
    cur->next->free = true;  
}
```

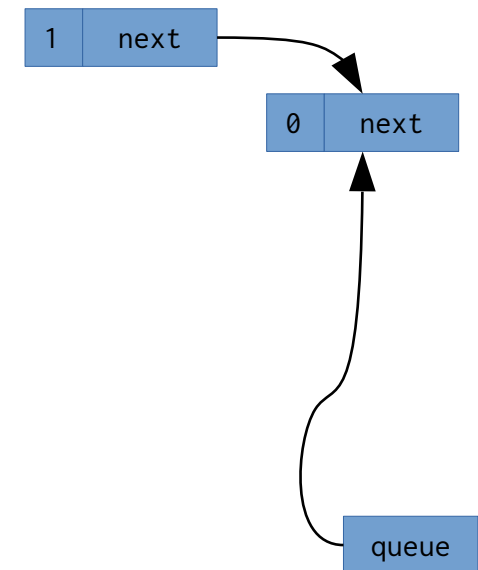

Synchronization w/ Locks

MCS-Lock – fair local spinning lock – Mellor-Crummey and Scott

```
struct mcs_node_t {
    mcs_node_t* next;
    bool free;
};

struct mcs_lock_t {
    mcs_node_t* queue;
};
```

```
void mcs_lock(mcs_lock_t* l, mcs_node_t* cur) {
    cur->next = NULL;
    cur->free = false;
    auto prev = fetch_and_store(&(l->queue), cur);
    if (prev) {
        prev->next = cur;
        do {} while (!cur->free);
    }
}
```

```
void mcs_unlock(mcs_lock_t* l, mcs_node_t* cur) {
    if (!cur->next) {
        if (cas(&(l->queue), cur, NULL)) return;
        do {} while (!cur->next);
    }
    cur->next->free = true;
}
```

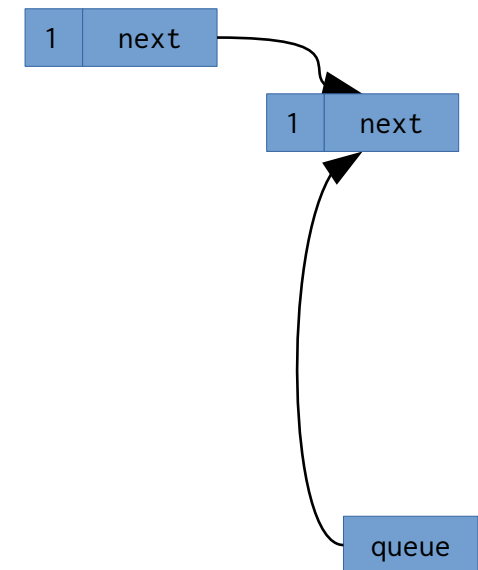

Synchronization w/ Locks

MCS-Lock – fair local spinning lock – Mellor-Crummey and Scott

```
struct mcs_node_t {  
    mcs_node_t* next;  
    bool free;  
};  
  
struct mcs_lock_t {  
    mcs_node_t* queue;  
};
```

```
void mcs_lock(mcs_lock_t* l, mcs_node_t* cur) {  
    cur->next = NULL;  
    cur->free = false;  
    auto prev = fetch_and_store(&(l->queue), cur);  
    if (prev) {  
        prev->next = cur;  
        do {} while (!cur->free);  
    }  
}
```

```
void mcs_unlock(mcs_lock_t* l, mcs_node_t* cur) {  
    if (!cur->next) {  
        if (cas(&(l->queue), cur, NULL)) return;  
        do {} while (!cur->next);  
    }  
    cur->next->free = true;  
}
```

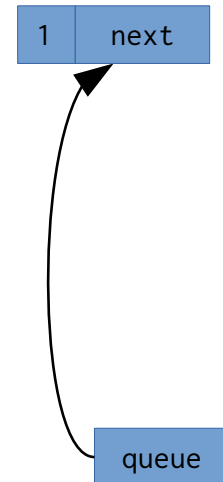

Synchronization w/ Locks

MCS-Lock – fair local spinning lock – Mellor-Crummey and Scott

```
struct mcs_node_t {  
    mcs_node_t* next;  
    bool free;  
};  
  
struct mcs_lock_t {  
    mcs_node_t* queue;  
};
```

```
void mcs_lock(mcs_lock_t* l, mcs_node_t* cur) {  
    cur->next = NULL;  
    cur->free = false;  
    auto prev = fetch_and_store(&(l->queue), cur);  
    if (prev) {  
        prev->next = cur;  
        do {} while (!cur->free);  
    }  
}
```

```
void mcs_unlock(mcs_lock_t* l, mcs_node_t* cur) {  
    if (!cur->next) {  
        if (cas(&(l->queue), cur, NULL)) return;  
        do {} while (!cur->next);  
    }  
    cur->next->free = true;  
}
```

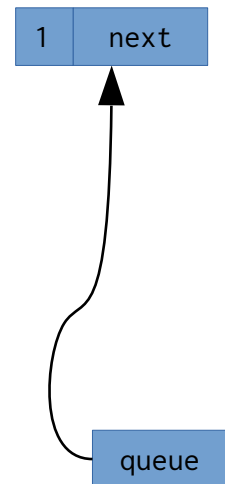

Synchronization w/ Locks

MCS-Lock – fair local spinning lock – Mellor-Crummey and Scott

```
struct mcs_node_t {  
    mcs_node_t* next;  
    bool free;  
};  
  
struct mcs_lock_t {  
    mcs_node_t* queue;  
};
```

```
void mcs_lock(mcs_lock_t* l, mcs_node_t* cur) {  
    cur->next = NULL;  
    cur->free = false;  
    auto prev = fetch_and_store(&(l->queue), cur);  
    if (prev) {  
        prev->next = cur;  
        do {} while (!cur->free);  
    }  
}
```

```
void mcs_unlock(mcs_lock_t* l, mcs_node_t* cur) {  
    if (!cur->next) {  
        if (cas(&(l->queue), cur, NULL)) return;  
        do {} while (!cur->next);  
    }  
    cur->next->free = true;  
}
```

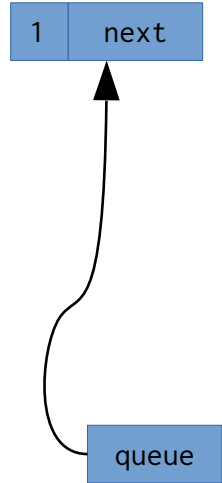

Synchronization w/ Locks

MCS-Lock – fair local spinning lock – Mellor-Crummey and Scott

```
struct mcs_node_t {  
    mcs_node_t* next;  
    bool free;  
};  
  
struct mcs_lock_t {  
    mcs_node_t* queue;  
};
```

```
void mcs_lock(mcs_lock_t* l, mcs_node_t* cur) {  
    cur->next = NULL;  
    cur->free = false;  
    auto prev = fetch_and_store(&(l->queue), cur);  
    if (prev) {  
        prev->next = cur;  
        do {} while (!cur->free);  
    }  
}
```

```
void mcs_unlock(mcs_lock_t* l, mcs_node_t* cur) {  
    if (!cur->next) {  
        if (cas(&(l->queue), cur, NULL)) return;  
        do {} while (!cur->next);  
    }  
    cur->next->free = true;  
}
```

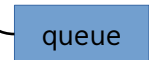

Synchronization w/ Locks

MCS-Lock – fair local spinning lock – Mellor-Crummey and Scott

```
struct mcs_node_t {  
    mcs_node_t* next;  
    bool free;  
};  
  
struct mcs_lock_t {  
    mcs_node_t* queue;  
};
```

```
void mcs_lock(mcs_lock_t* l, mcs_node_t* cur) {  
    cur->next = NULL;  
    cur->free = false;  
    auto prev = fetch_and_store(&(l->queue), cur);  
    if (prev) {  
        prev->next = cur;  
        do {} while (!cur->free);  
    }  
}
```

```
void mcs_unlock(mcs_lock_t* l, mcs_node_t* cur) {  
    if (!cur->next) {  
        if (cas(&(l->queue), cur, NULL)) return;  
        do {} while (!cur->next);  
    }  
    cur->next->free = true;  
}
```

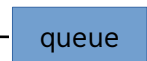
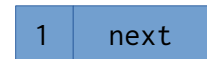

Synchronization w/ Locks

MCS-Lock – fair local spinning lock – Mellor-Crummey and Scott

```
struct mcs_node_t {  
    mcs_node_t* next;  
    bool free;  
};  
  
struct mcs_lock_t {  
    mcs_node_t* queue;  
};
```

```
void mcs_lock(mcs_lock_t* l, mcs_node_t* cur) {  
    cur->next = NULL;  
    cur->free = false;  
    auto prev = fetch_and_store(&(l->queue), cur);  
    if (prev) {  
        prev->next = cur;  
        do {} while (!cur->free);  
    }  
}
```

```
void mcs_unlock(mcs_lock_t* l, mcs_node_t* cur) {  
    if (!cur->next) {  
        if (cas(&(l->queue), cur, NULL)) return;  
        do {} while (!cur->next);  
    }  
    cur->next->free = true;  
}
```

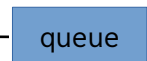
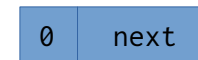
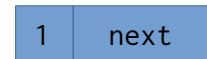

Synchronization w/ Locks

MCS-Lock – fair local spinning lock – Mellor-Crummey and Scott

```
struct mcs_node_t {  
    mcs_node_t* next;  
    bool free;  
};  
  
struct mcs_lock_t {  
    mcs_node_t* queue;  
};
```

```
void mcs_lock(mcs_lock_t* l, mcs_node_t* cur) {  
    cur->next = NULL;  
    cur->free = false;  
    auto prev = fetch_and_store(&(l->queue), cur);  
    if (prev) {  
        prev->next = cur;  
        do {} while (!cur->free);  
    }  
}
```

```
void mcs_unlock(mcs_lock_t* l, mcs_node_t* cur) {  
    if (!cur->next) {  
        if (cas(&(l->queue), cur, NULL)) return;  
        do {} while (!cur->next);  
    }  
    cur->next->free = true;  
}
```

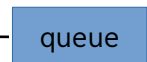
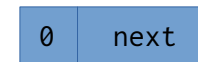

Synchronization w/ Locks

MCS-Lock – fair local spinning lock – Mellor-Crummey and Scott

```
struct mcs_node_t {  
    mcs_node_t* next;  
    bool free;  
};  
  
struct mcs_lock_t {  
    mcs_node_t* queue;  
};
```

```
void mcs_lock(mcs_lock_t* l, mcs_node_t* cur) {  
    cur->next = NULL;  
    cur->free = false;  
    auto prev = fetch_and_store(&(l->queue), cur);  
    if (prev) {  
        prev->next = cur;  
        do {} while (!cur->free);  
    }  
}
```

```
void mcs_unlock(mcs_lock_t* l, mcs_node_t* cur) {  
    if (!cur->next) {  
        if (cas(&(l->queue), cur, NULL)) return;  
        do {} while (!cur->next);  
    }  
    cur->next->free = true;  
}
```

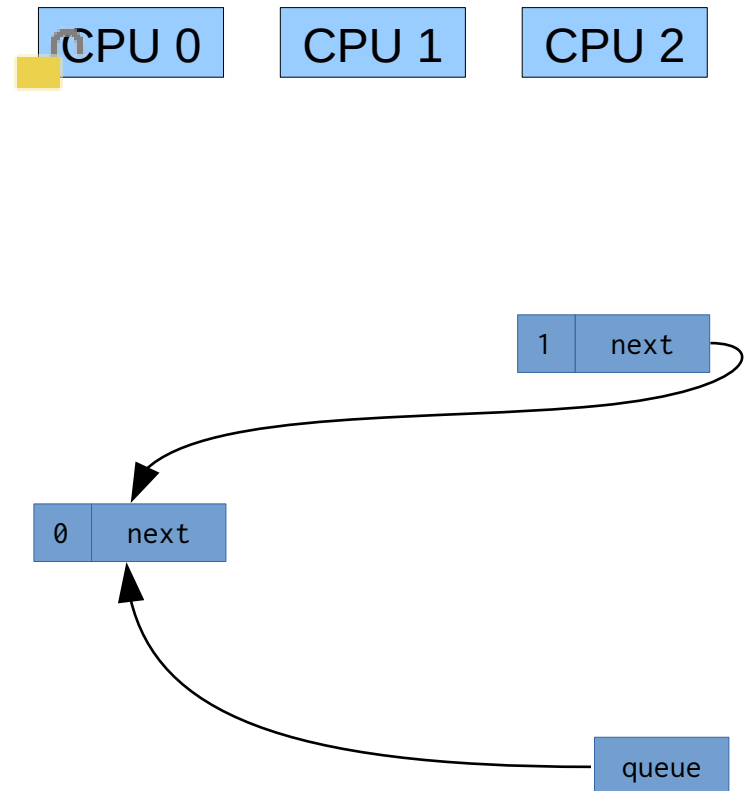

Synchronization w/ Locks

MCS-Lock – fair local spinning lock – Mellor-Crummey and Scott

```
struct mcs_node_t {
    mcs_node_t* next;
    bool free;
};

struct mcs_lock_t {
    mcs_node_t* queue;
};
```

```
void mcs_lock(mcs_lock_t* l, mcs_node_t* cur) {
    cur->next = NULL;
    cur->free = false;
    auto prev = fetch_and_store(&(l->queue), cur);
    if (prev) {
        prev->next = cur;
        do {} while (!cur->free);
    }
}
```

```
void mcs_unlock(mcs_lock_t* l, mcs_node_t* cur) {
    if (!cur->next) {
        if (cas(&(l->queue), cur, NULL)) return;
        do {} while (!cur->next);
    }
    cur->next->free = true;
}
```

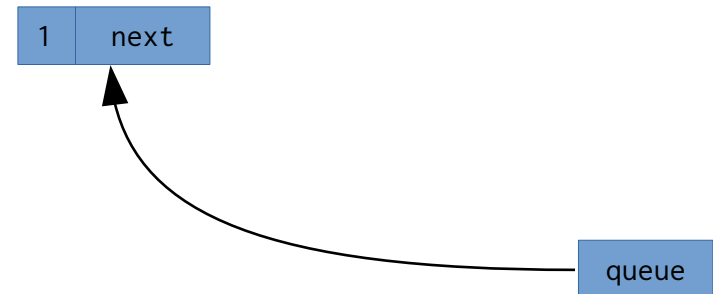
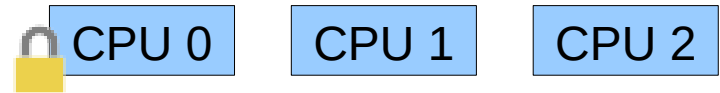

Synchronization w/ Locks

MCS-Lock – fair local spinning lock – Mellor-Crummey and Scott

```
struct mcs_node_t {  
    mcs_node_t* next;  
    bool free;  
};  
  
struct mcs_lock_t {  
    mcs_node_t* queue;  
};
```

```
void mcs_lock(mcs_lock_t* l, mcs_node_t* cur) {  
    cur->next = NULL;  
    cur->free = false;  
    auto prev = fetch_and_store(&(l->queue), cur);  
    if (prev) {  
        prev->next = cur;  
        do {} while (!cur->free);  
    }  
}
```

```
void mcs_unlock(mcs_lock_t* l, mcs_node_t* cur) {  
    if (!cur->next) {  
        if (cas(&(l->queue), cur, NULL)) return;  
        do {} while (!cur->next);  
    }  
    cur->next->free = true;  
}
```

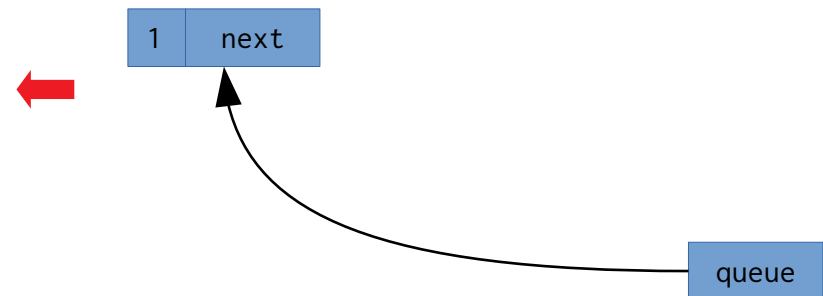
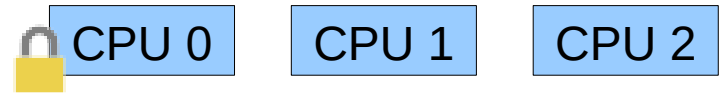

Synchronization w/ Locks

MCS-Lock – fair local spinning lock – Mellor-Crummey and Scott

```
struct mcs_node_t {  
    mcs_node_t* next;  
    bool free;  
};  
  
struct mcs_lock_t {  
    mcs_node_t* queue;  
};
```

```
void mcs_lock(mcs_lock_t* l, mcs_node_t* cur) {  
    cur->next = NULL;  
    cur->free = false;  
    auto prev = fetch_and_store(&(l->queue), cur);  
    if (prev) {  
        prev->next = cur;  
        do {} while (!cur->free);  
    }  
}
```

```
void mcs_unlock(mcs_lock_t* l, mcs_node_t* cur) {  
    if (!cur->next) {  
        if (cas(&(l->queue), cur, NULL)) return;  
        do {} while (!cur->next);  
    }  
    cur->next->free = true;  
}
```

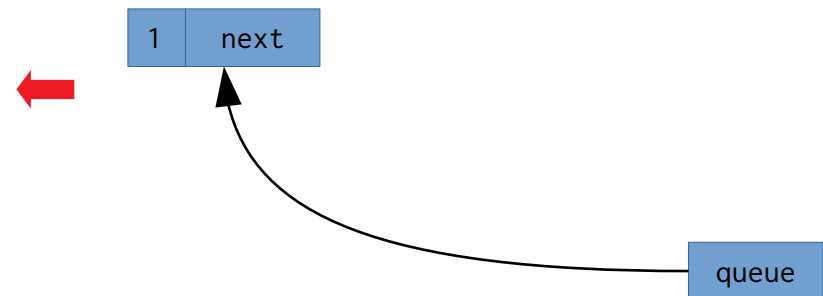
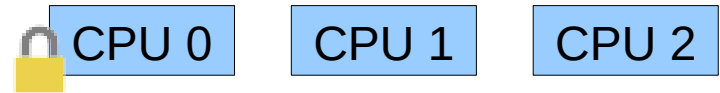

Synchronization w/ Locks

MCS-Lock – fair local spinning lock – Mellor-Crummey and Scott

```
struct mcs_node_t {
    mcs_node_t* next;
    bool free;
};

struct mcs_lock_t {
    mcs_node_t* queue;
};
```

```
void mcs_lock(mcs_lock_t* l, mcs_node_t* cur) {
    cur->next = NULL;
    cur->free = false;
    auto prev = fetch_and_store(&(l->queue), cur);
    if (prev) {
        prev->next = cur;
        do {} while (!cur->free);
    }
}
```

```
void mcs_unlock(mcs_lock_t* l, mcs_node_t* cur) {
    if (!cur->next) {
        if (cas(&(l->queue), cur, NULL)) return;
        do {} while (!cur->next);
    }
    cur->next->free = true;
}
```

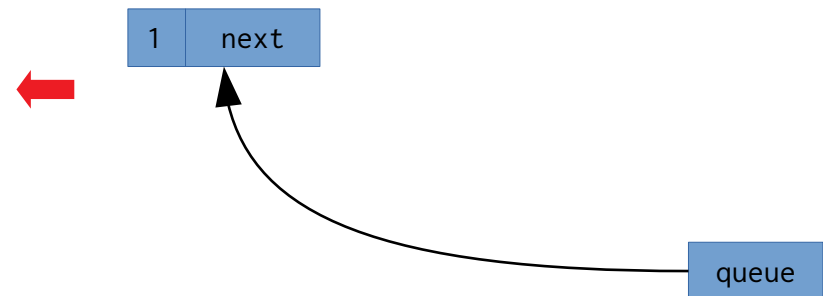

Synchronization w/ Locks

MCS-Lock – fair local spinning lock – Mellor-Crummey and Scott

```
struct mcs_node_t {
    mcs_node_t* next;
    bool free;
};

struct mcs_lock_t {
    mcs_node_t* queue;
};
```

CPU 0

CPU 1

CPU 2

```
void mcs_lock(mcs_lock_t* l, mcs_node_t* cur) {
    cur->next = NULL;
    cur->free = false;
    auto prev = fetch_and_store(&(l->queue), cur);
    if (prev) {
        prev->next = cur;
        do {} while (!cur->free);
    }
}
```

```
void mcs_unlock(mcs_lock_t* l, mcs_node_t* cur) {
    if (!cur->next) {
        if (cas(&(l->queue), cur, NULL)) return;
        do {} while (!cur->next);
    }
    cur->next->free = true;
}
```

queue

Synchronization w/ Locks

MCS-Lock – Performance

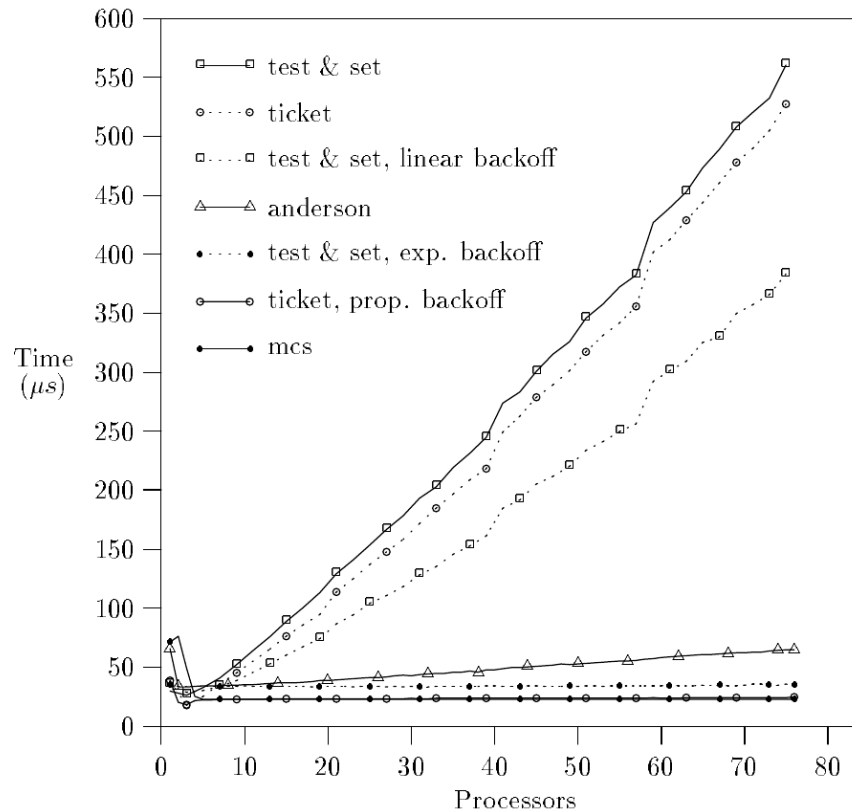

Figure 1 Comparison of different lock implementations.

Mellor-Crummey, Scott [1991]: "Algorithms for Scalable Synchronization on Shared Memory Multiprocessors"

Synchronization w/ Locks

MCS-Lock – Performance

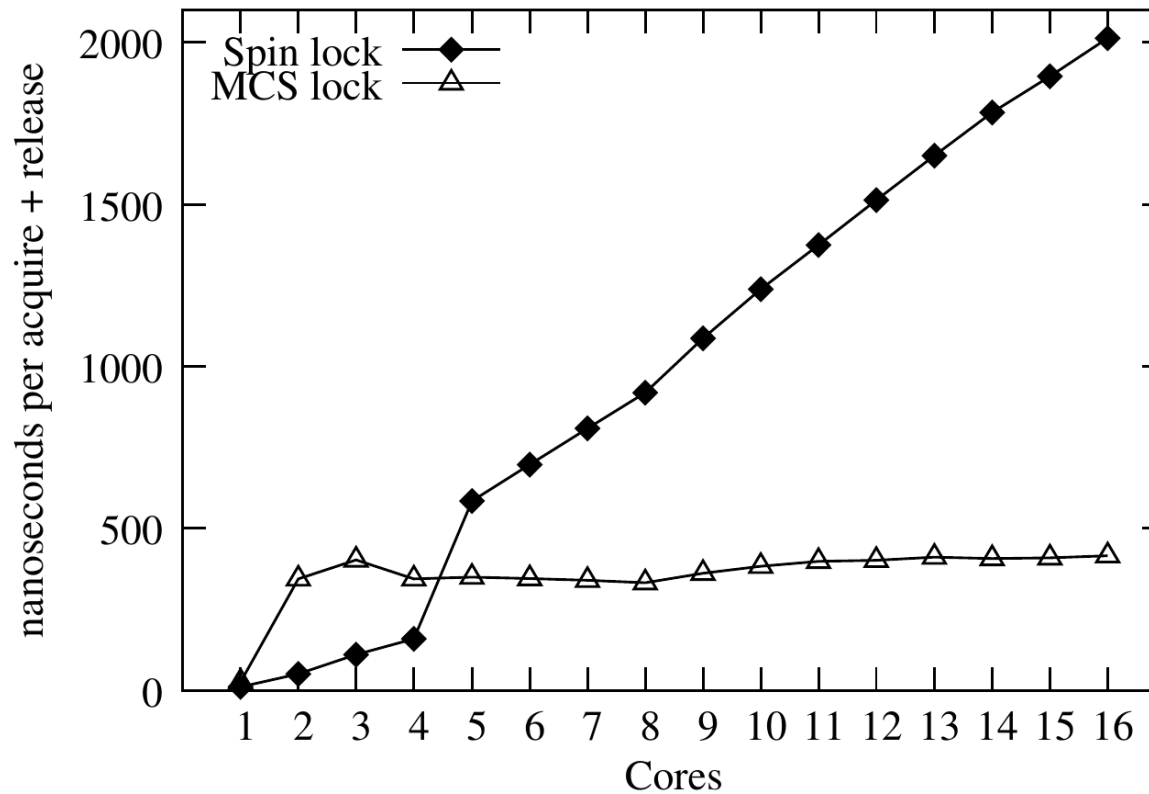

Figure 2 Comparison of the overhead of spin-locks and MCS-locks on an 16 core AMD Opteron. Boyd-Wickizer et al. [2008]: “Corey: An Operating System for Many Cores”

Overview

- Introduction
- Hardware Primitives
- Synchronization with Locks (Part I)
 - Properties
 - Locks
 - Spin Lock (Test & Set Lock)
 - Test & Test & Set Lock
 - Ticket Lock
- Synchronization without Locks
- Synchronization with Locks (Part II)
 - MCS Lock
 - Performance
 - Special Issues
 - Timeouts
 - Reader Writer Lock
 - Lockholder Preemption
 - Monitor, Mwait

Synchronization w/ Locks

Timeouts – Abort lock()-Operation

- Give up locking after a specified timeout
- Stop threads which are currently waiting for a lock

Synchronization w/ Locks

Timeouts – Abort lock()-Operation

- Give up locking after a specified timeout
- Stop threads which are currently waiting for a lock
 - Test & Set Locks → stop trying to acquire lock

Synchronization w/ Locks

Timeouts – Abort lock()-Operation

- Give up locking after a specified timeout
- Stop threads which are currently waiting for a lock
 - Test & Set Locks
 - Ticket Lock

Synchronization w/ Locks

Timeouts – Abort lock()-Operation

- Give up locking after a specified timeout
- Stop threads which are currently waiting for a lock

- Test & Set Locks
- Ticket Lock

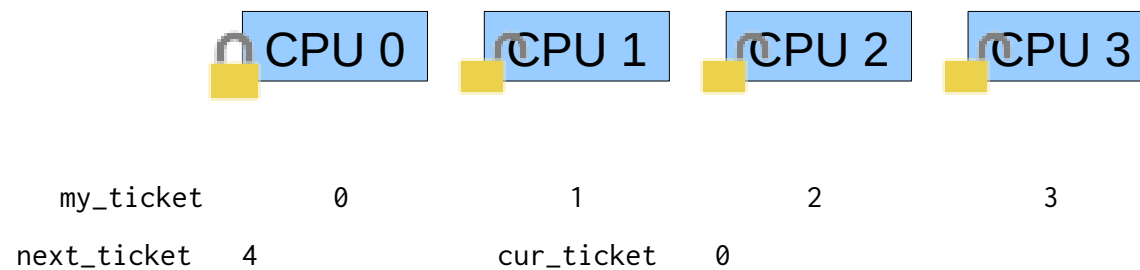

Synchronization w/ Locks

Timeouts – Abort lock()-Operation

- Give up locking after a specified timeout
- Stop threads which are currently waiting for a lock
- Test & Set Locks
- Ticket Lock → stop trying to acquire lock

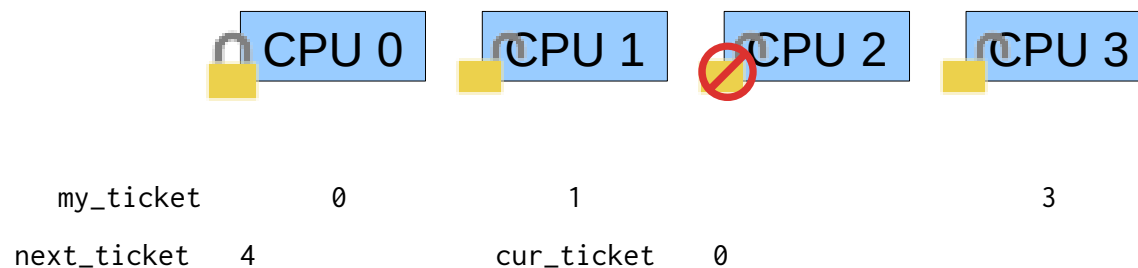

Synchronization w/ Locks

Timeouts – Abort lock()-Operation

- Give up locking after a specified timeout
- Stop threads which are currently waiting for a lock
- Test & Set Locks
- Ticket Lock → stop trying to acquire lock

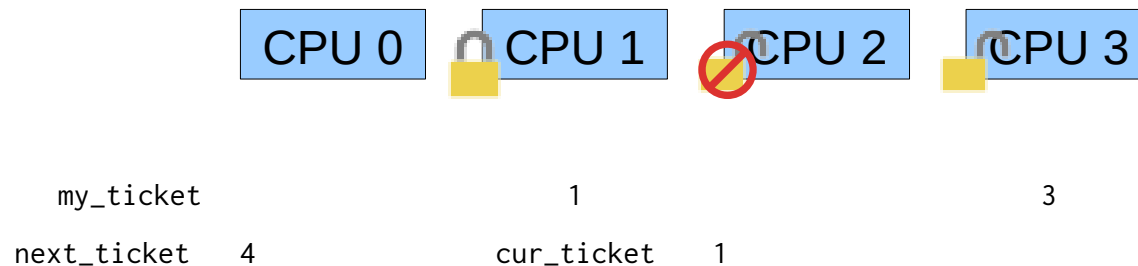

Synchronization w/ Locks

Timeouts – Abort lock()-Operation

- Give up locking after a specified timeout
- Stop threads which are currently waiting for a lock
- Test & Set Locks
- Ticket Lock → stop trying to acquire lock

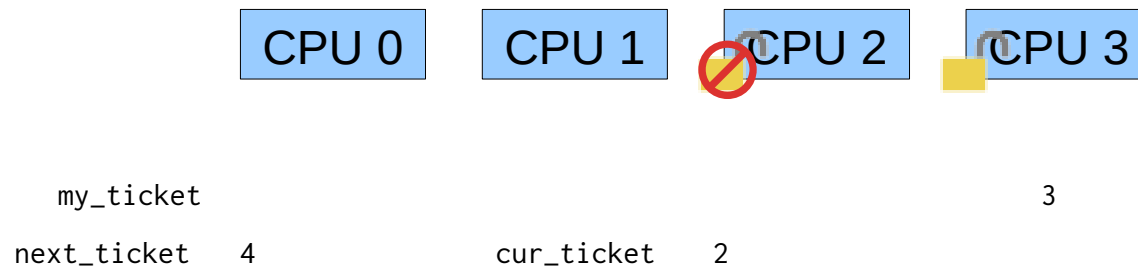

Synchronization w/ Locks

Timeouts – Abort lock()-Operation

- Give up locking after a specified timeout
- Stop threads which are currently waiting for a lock
- Test & Set Locks
- Ticket Lock → stop trying to acquire lock

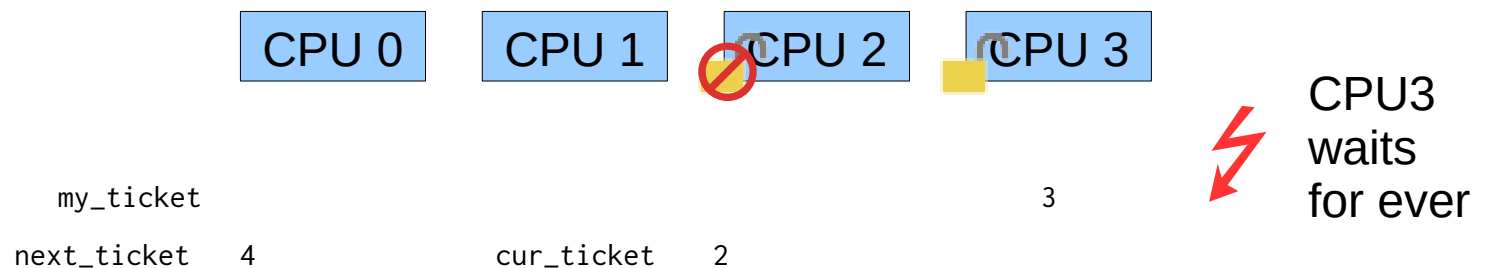

Synchronization w/ Locks

Timeouts – Abort lock()-Operation

- Give up locking after a specified timeout
- Stop threads which are currently waiting for a lock
- Test & Set Locks
- Ticket Lock → stop trying to acquire lock + increase `cur_ticket`

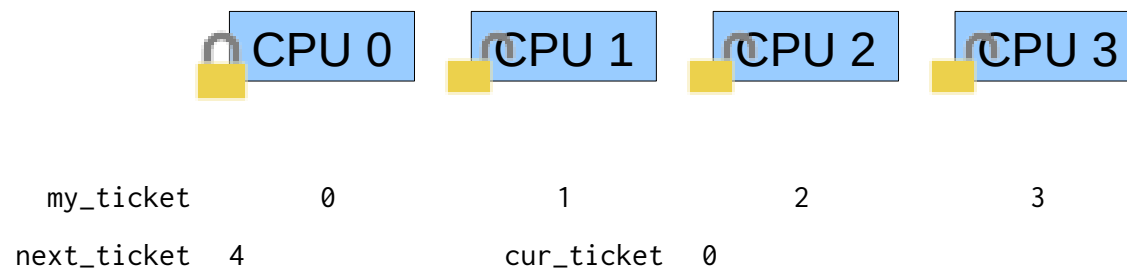

Synchronization w/ Locks

Timeouts – Abort lock()-Operation

- Give up locking after a specified timeout
- Stop threads which are currently waiting for a lock
- Test & Set Locks
- Ticket Lock → stop trying to acquire lock + increase `cur_ticket`

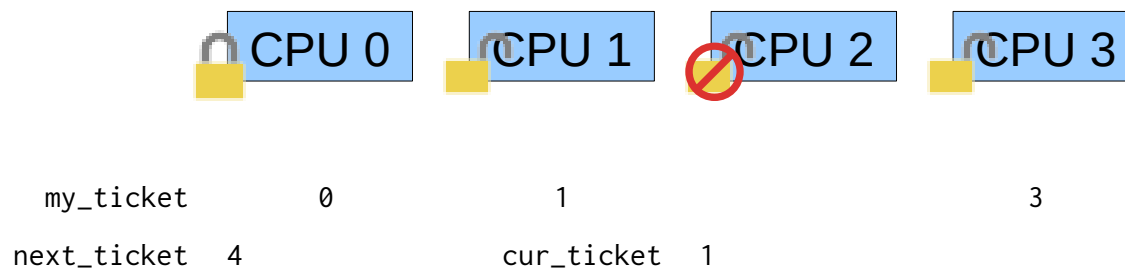

Synchronization w/ Locks

Timeouts – Abort lock()-Operation

- Give up locking after a specified timeout
- Stop threads which are currently waiting for a lock
- Test & Set Locks
- Ticket Lock → stop trying to acquire lock + increase `cur_ticket`

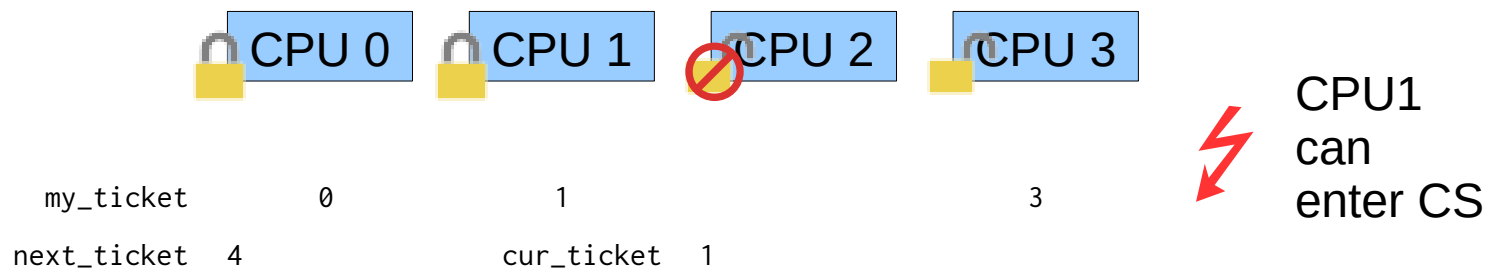

Synchronization w/ Locks

Timeouts – Abort lock()-Operation

- Give up locking after a specified timeout
- Stop threads which are currently waiting for a lock
- Test & Set Locks
- Ticket Lock → stop trying to acquire the lock + increase `cur_ticket`

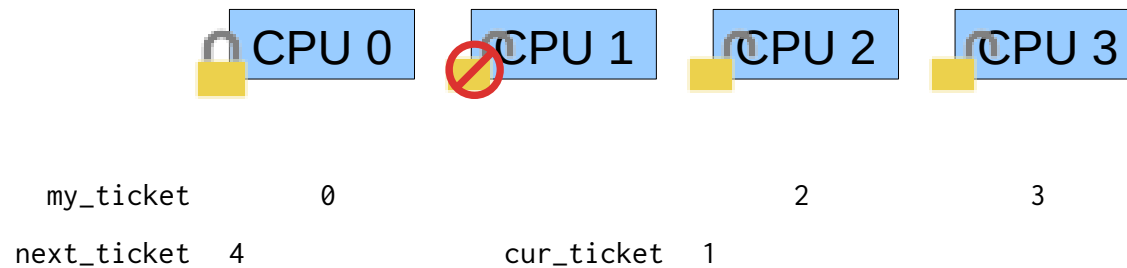

Synchronization w/ Locks

Timeouts – Abort lock()-Operation

- Give up locking after a specified timeout
- Stop threads which are currently waiting for a lock
- Test & Set Locks
- Ticket Lock → stop trying to acquire the lock + increase `cur_ticket`

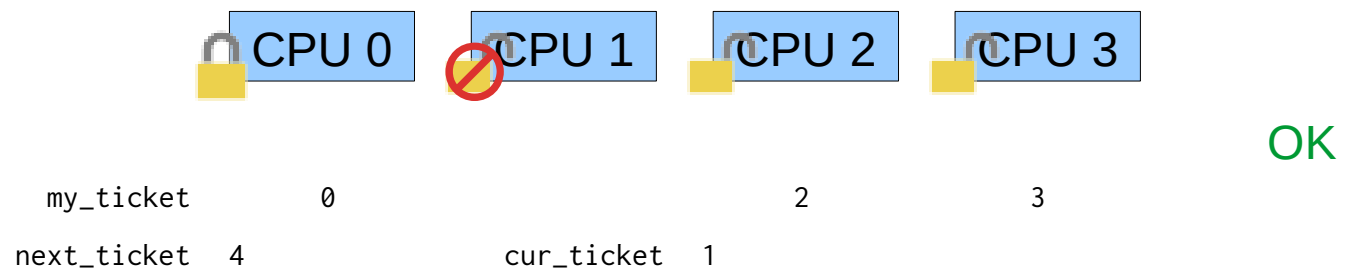

Synchronization w/ Locks

Timeouts – Abort lock()-Operation

- Give up locking after a specified timeout
- Stop threads which are currently waiting for a lock

- Test & Set Locks

- Ticket Lock → stop trying to acquire the lock + alter `next_ticket` and `my_ticket`

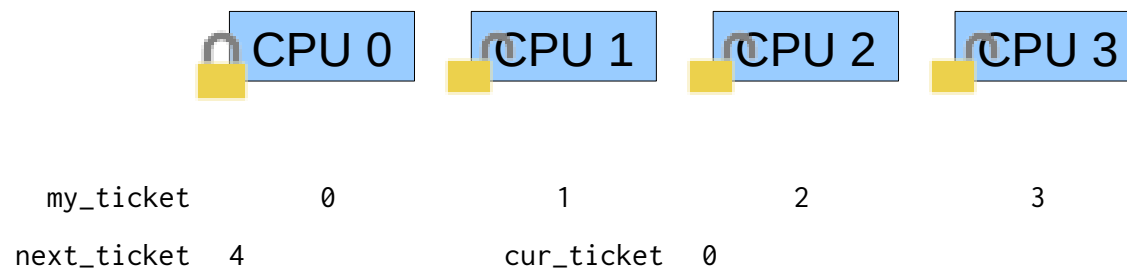

Synchronization w/ Locks

Timeouts – Abort lock()-Operation

- Give up locking after a specified timeout
- Stop threads which are currently waiting for a lock

- Test & Set Locks

- Ticket Lock → stop trying to acquire the lock + alter `next_ticket` and `my_ticket`

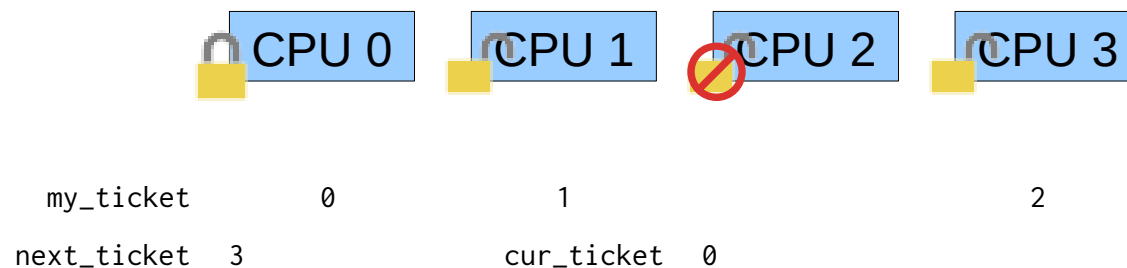

Synchronization w/ Locks

Timeouts – Abort lock()-Operation

- Give up locking after a specified timeout
- Stop threads which are currently waiting for a lock

- Test & Set Locks

- Ticket Lock → stop trying to acquire the lock + alter `next_ticket` and `my_ticket`

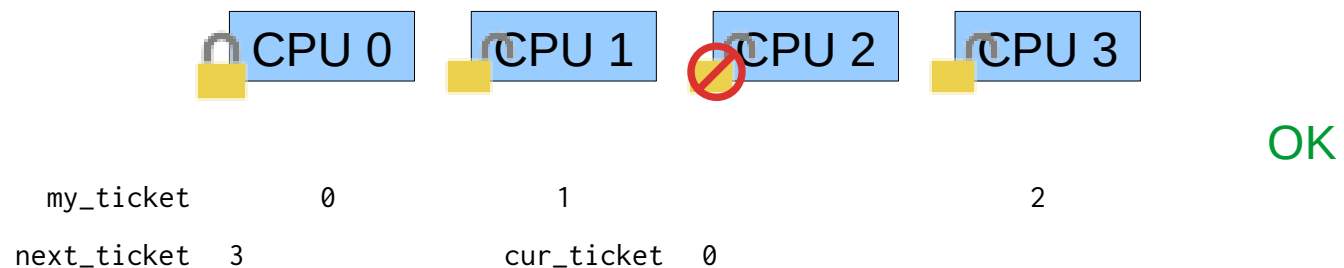

Synchronization w/ Locks

Timeouts – Abort lock()-Operation

- Give up locking after a specified timeout
- Stop threads which are currently waiting for a lock

- Test & Set Locks

- Ticket Lock → stop trying to acquire the lock + alter `next_ticket` and `my_ticket`

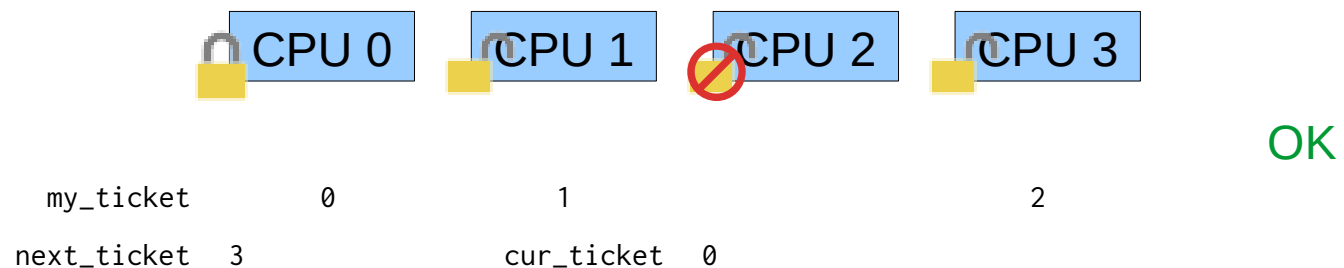

Very tricky to implement!

Synchronization w/ Locks

Timeouts – Abort lock()-Operation

- Give up locking after a specified timeout
- Stop threads which are currently waiting for a lock
 - Test & Set Locks → stop trying to acquire the lock
 - Ticket Lock → stop trying to acquire the lock + alter `next_ticket` and `my_ticket`
 - MCS-Lock → dequeue from the queue of waiters (exercise)

Synchronization w/ Locks

Reader Writer Locks

- Lock differentiates two types of lock holders:
 - Readers
 - Do not modify the object
 - Multiple can use the object at the same time
 - Writers
 - Modify the object
 - Must have exclusive access to the object (no other readers or writers)
- Locks can have different level of fairness
 - Readers and writers use the object in the order they appear → fair
 - Later readers overtake earlier writers → unfair for writers
 - Later writers overtake earlier readers → unfair for readers

Synchronization w/ Locks

Fair Ticket Reader Writer Lock

```
struct rw_lock_t {  
    rw_union_t cur_ticket;  
    rw_union_t next_ticket;  
};
```

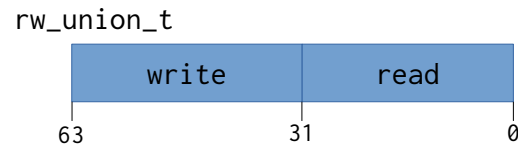

```
void lock_read(rw_lock_t *l) {  
    auto my_ticket = xadd(&(l->next_ticket), 1);  
    do {} while (l->cur_ticket.write != my_ticket.write);  
}
```

```
void lock_write(rw_lock_t *l) {  
    auto my_ticket = xadd(&(l->next_ticket.write), 1);  
    do {} while (l->cur_ticket != my_ticket);  
}
```

```
void unlock_read(rw_lock_t *l) {  
    xadd(&(l->cur_ticket.read), 1);  
}
```

```
void unlock_write(rw_lock_t *l) {  
    l->cur_ticket.write++;  
}
```

Synchronization w/ Locks

Fair Ticket Reader Writer Lock

```
struct rw_lock_t {  
    rw_union_t cur_ticket;  
    rw_union_t next_ticket;  
};
```

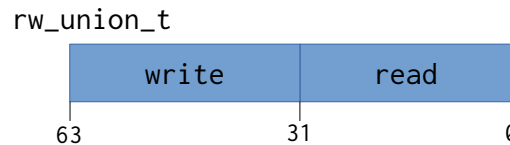

```
void lock_read(rw_lock_t *l) {  
    auto my_ticket = xadd(&l->next_ticket, 1);  
    do {} while (l->cur_ticket.write != my_ticket.write);  
}
```



```
void lock_write(rw_lock_t *l) {  
    auto my_ticket = xadd(&l->next_ticket.write, 1);  
    do {} while (l->cur_ticket != my_ticket);  
}
```

```
void unlock_read(rw_lock_t *l) {  
    xadd(&l->cur_ticket.read, 1);  
}
```

```
void unlock_write(rw_lock_t *l) {  
    l->cur_ticket.write++;  
}
```

my_ticket
next_ticket 0|0 cur_ticket 0|0

Synchronization w/ Locks

Fair Ticket Reader Writer Lock

```
struct rw_lock_t {  
    rw_union_t cur_ticket;  
    rw_union_t next_ticket;  
};
```

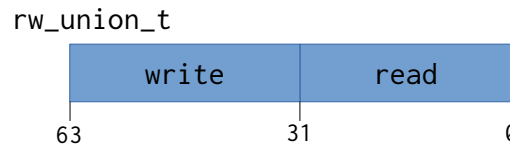

```
void lock_read(rw_lock_t *l) {  
    auto my_ticket = xadd(&(l->next_ticket), 1);  
    do {} while (l->cur_ticket.write != my_ticket.write);  
}
```

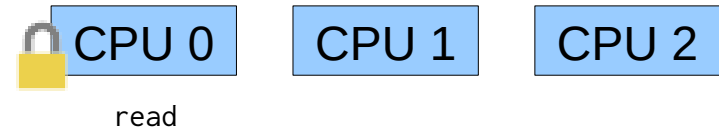

```
void lock_write(rw_lock_t *l) {  
    auto my_ticket = xadd(&(l->next_ticket.write), 1);  
    do {} while (l->cur_ticket != my_ticket);  
}
```

```
void unlock_read(rw_lock_t *l) {  
    xadd(&(l->cur_ticket.read), 1);  
}
```

```
void unlock_write(rw_lock_t *l) {  
    l->cur_ticket.write++;  
}
```

my_ticket 0|0
next_ticket 0|1

cur_ticket 0|0

Synchronization w/ Locks

Fair Ticket Reader Writer Lock

```
struct rw_lock_t {  
    rw_union_t cur_ticket;  
    rw_union_t next_ticket;  
};
```

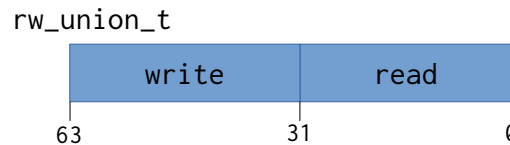

```
void lock_read(rw_lock_t *l) {  
    auto my_ticket = xadd(&(l->next_ticket), 1);  
    do {} while (l->cur_ticket.write != my_ticket.write);  
}
```

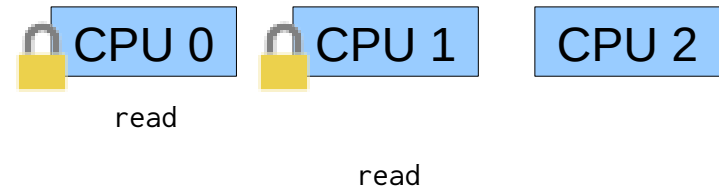

```
void lock_write(rw_lock_t *l) {  
    auto my_ticket = xadd(&(l->next_ticket.write), 1);  
    do {} while (l->cur_ticket != my_ticket);  
}
```

```
void unlock_read(rw_lock_t *l) {  
    xadd(&(l->cur_ticket.read), 1);  
}
```

```
void unlock_write(rw_lock_t *l) {  
    l->cur_ticket.write++;  
}
```

my_ticket	0 0	0 1	
next_ticket	0 2	cur_ticket	0 0

Synchronization w/ Locks

Fair Ticket Reader Writer Lock

```
struct rw_lock_t {  
    rw_union_t cur_ticket;  
    rw_union_t next_ticket;  
};
```

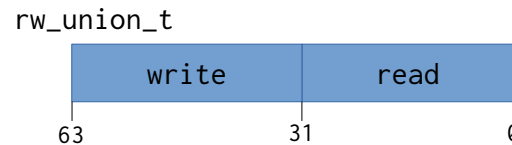

```
void lock_read(rw_lock_t *l) {  
    auto my_ticket = xadd(&(l->next_ticket), 1);  
    do {} while (l->cur_ticket.write != my_ticket.write);  
}
```

```
void lock_write(rw_lock_t *l) {  
    auto my_ticket = xadd(&(l->next_ticket.write), 1);  
    do {} while (l->cur_ticket != my_ticket);  
}
```

```
void unlock_read(rw_lock_t *l) {  
    xadd(&(l->cur_ticket.read), 1);  
}
```

```
void unlock_write(rw_lock_t *l) {  
    l->cur_ticket.write++;  
}
```

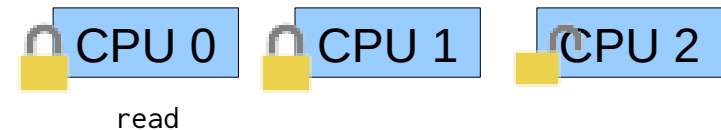

my_ticket	0 0	0 1	0 2
next_ticket	1 2	cur_ticket	0 0

Synchronization w/ Locks

Fair Ticket Reader Writer Lock

```
struct rw_lock_t {  
    rw_union_t cur_ticket;  
    rw_union_t next_ticket;  
};
```

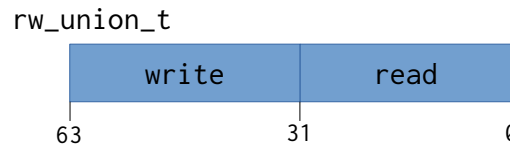

```
void lock_read(rw_lock_t *l) {  
    auto my_ticket = xadd(&(l->next_ticket), 1);  
    do {} while (l->cur_ticket.write != my_ticket.write);  
}
```

```
void lock_write(rw_lock_t *l) {  
    auto my_ticket = xadd(&(l->next_ticket.write), 1);  
    do {} while (l->cur_ticket != my_ticket);  
}
```

```
void unlock_read(rw_lock_t *l) {  
    xadd(&(l->cur_ticket.read), 1);  
}
```

```
void unlock_write(rw_lock_t *l) {  
    l->cur_ticket.write++;  
}
```



read

read

write

done

my_ticket
next_ticket 1|2

0|1
cur_ticket

0|2
0|1

Synchronization w/ Locks

Fair Ticket Reader Writer Lock

```
struct rw_lock_t {  
    rw_union_t cur_ticket;  
    rw_union_t next_ticket;  
};
```

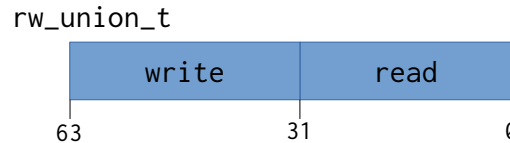

```
void lock_read(rw_lock_t *l) {  
    auto my_ticket = xadd(&(l->next_ticket), 1);  
    do {} while (l->cur_ticket.write != my_ticket.write);  
}
```

```
void lock_write(rw_lock_t *l) {  
    auto my_ticket = xadd(&(l->next_ticket.write), 1);  
    do {} while (l->cur_ticket != my_ticket);  
}
```

```
void unlock_read(rw_lock_t *l) {  
    xadd(&(l->cur_ticket.read), 1);  
}
```

```
void unlock_write(rw_lock_t *l) {  
    l->cur_ticket.write++;  
}
```



read

read

write

done

done

my_ticket
next_ticket 1|2

cur_ticket 0|2

Synchronization w/ Locks

Fair Ticket Reader Writer Lock

```
struct rw_lock_t {
    rw_union_t cur_ticket;
    rw_union_t next_ticket;
};
```

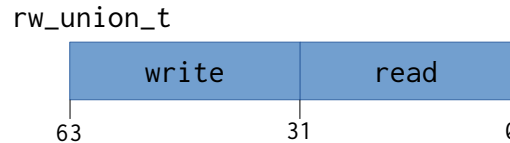

```
void lock_read(rw_lock_t *l) {
    auto my_ticket = xadd(&l->next_ticket, 1);
    do {} while (l->cur_ticket.write != my_ticket.write);
}
```

```
void lock_write(rw_lock_t *l) {
    auto my_ticket = xadd(&l->next_ticket.write, 1);
    do {} while (l->cur_ticket != my_ticket);
}
```

```
void unlock_read(rw_lock_t *l) {
    xadd(&l->cur_ticket.read, 1);
}
```

```
void unlock_write(rw_lock_t *l) {
    l->cur_ticket.write++;
}
```

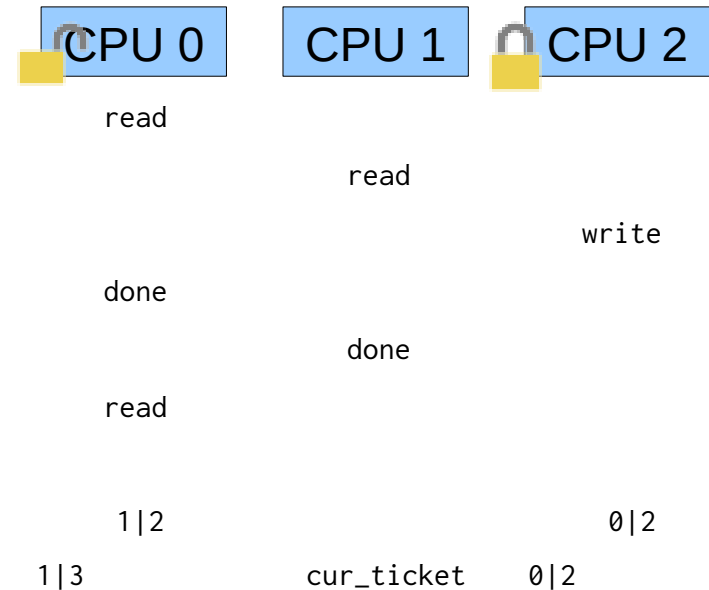

Synchronization w/ Locks

Fair Ticket Reader Writer Lock

```
struct rw_lock_t {
    rw_union_t cur_ticket;
    rw_union_t next_ticket;
};
```

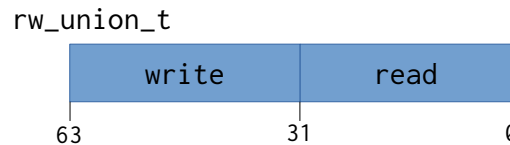

```
void lock_read(rw_lock_t *l) {
    auto my_ticket = xadd(&l->next_ticket, 1);
    do {} while (l->cur_ticket.write != my_ticket.write);
}
```

```
void lock_write(rw_lock_t *l) {
    auto my_ticket = xadd(&l->next_ticket.write, 1);
    do {} while (l->cur_ticket != my_ticket);
}
```

```
void unlock_read(rw_lock_t *l) {
    xadd(&l->cur_ticket.read, 1);
}
```

```
void unlock_write(rw_lock_t *l) {
    l->cur_ticket.write++;
}
```

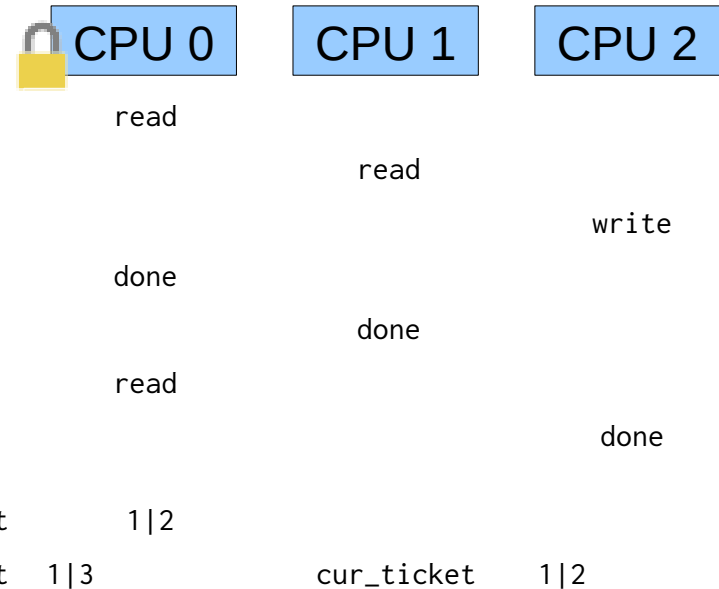

Synchronization w/ Locks

Fair Ticket Reader Writer Lock

```
struct rw_lock_t {  
    rw_union_t cur_ticket;  
    rw_union_t next_ticket;  
};
```

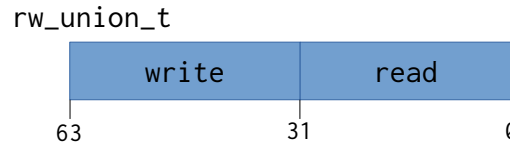

```
void lock_read(rw_lock_t *l) {  
    auto my_ticket = xadd(&(l->next_ticket), 1);  
    do {} while (l->cur_ticket.write != my_ticket.write);  
}
```

```
void lock_write(rw_lock_t *l) {  
    auto my_ticket = xadd(&(l->next_ticket.write), 1);  
    do {} while (l->cur_ticket != my_ticket);  
}
```

```
void unlock_read(rw_lock_t *l) {  
    xadd(&(l->cur_ticket.read), 1);  
}
```

```
void unlock_write(rw_lock_t *l) {  
    l->cur_ticket.write++;  
}
```

Difficult to get right!

- No overflows within each counter
 - Counters must be large enough so that all threads can be readers or writers
- No overflow from one counter to another
 - Read counter must not overflow into write counter → protection bit

Synchronization w/ Locks

Lockholder Preemption

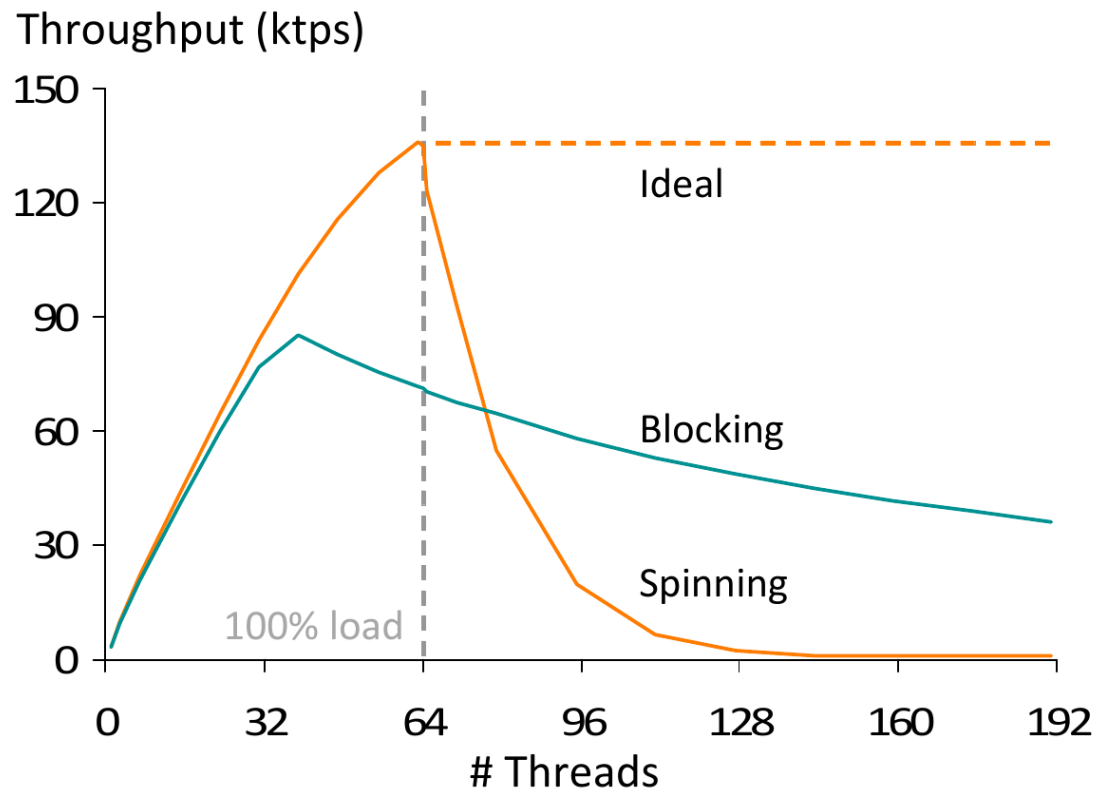

Figure 3 Comparison of the operation throughput using blocking or spinning primitives.
Johnson et al. [2010]: “Decoupling Contention Management from Scheduling”

Synchronization w/ Locks

Lockholder Preemption

- Spinning time of a CPU is increased by the time the current lockholder can not execute
 - Lockholder gets preempted by other spinning threads on the same CPU
 - Especially bad for Ticket and MCS-Locks
- Blocking instead of spinning reduces the load on the system and can thereby help preventing lockholder preemption
- Prohibit preemption of the lockholder by disabling interrupts while being in CS
 - `cli + sti` in combination with `pushf + popf`

Synchronization w/ Locks

Lockholder Preemption

- Spinning time of a CPU is increased by the time the current lockholder can not execute
 - Lockholder gets preempted by other spinning threads on the same CPU
 - Especially bad for Ticket and MCS-Locks
- Blocking instead of spinning reduces the load on the system and can thereby help preventing lockholder preemption
- Prohibit preemption of the lockholder by disabling interrupts while being in CS
 - `cli + sti` in combination with `pushf + popf`

Only possible in the kernel! Very dangerous!

Synchronization w/ Locks

Monitor, Mwait

- Possibility to stop the CPU/HT while waiting for a lock (only x86)
 - Can be used to put a CPU in a sleep state
 - Allows better usage of the remaining resources
- `monitor` – watches a given cache line
- `mwait` – stops CPU/HT until write to monitored cache line or interrupt

```
while (trigger != 1) {  
    monitor(&trigger);  
    if (trigger != 1)  
        mwait  
}
```

Synchronization w/ Locks

Monitor, Mwait

- Possibility to stop the CPU/HT while waiting for a lock (only x86)
 - Can be used to put a CPU in a sleep state
 - Allows better usage of the remaining resources
- `monitor` – watches a given cache line
- `mwait` – stops CPU/HT until write to monitored cache line or interrupt

CPU 0

CPU 1

```
while (trigger != 1) {  
    monitor(&trigger);  
    if (trigger != 1)  
        mwait  
}
```

Synchronization w/ Locks

Monitor, Mwait

- Possibility to stop the CPU/HT while waiting for a lock (only x86)
 - Can be used to put a CPU in a sleep state
 - Allows better usage of the remaining resources
- `monitor` – watches a given cache line
- `mwait` – stops CPU/HT until write to monitored cache line or interrupt

```
while (trigger != 1) {  
    monitor(&trigger);  
    if (trigger != 1)  
        mwait  
}
```

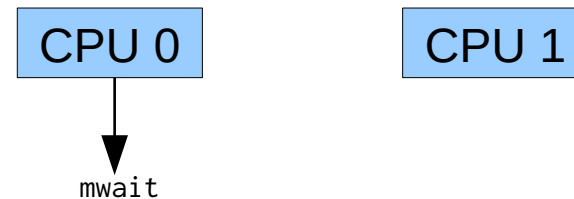

Synchronization w/ Locks

Monitor, Mwait

- Possibility to stop the CPU/HT while waiting for a lock (only x86)
 - Can be used to put a CPU in a sleep state
 - Allows better usage of the remaining resources
- `monitor` – watches a given cache line
- `mwait` – stops CPU/HT until write to monitored cache line or interrupt

```
while (trigger != 1) {  
    monitor(&trigger);  
    if (trigger != 1)  
        mwait  
}
```

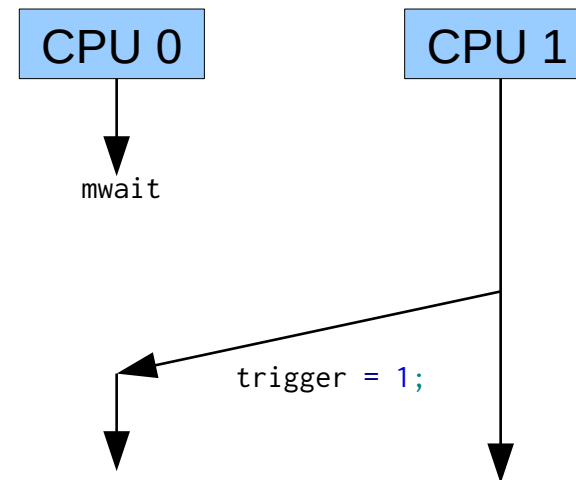

Synchronization w/ Locks

Monitor, Mwait

- Possibility to stop the CPU/HT while waiting for a lock (only x86)
 - Can be used to put a CPU in a sleep state
 - Allows better usage of the remaining resources
- `monitor` – watches a given cache line
- `mwait` – stops CPU/HT until write to monitored cache line or interrupt

```
while (trigger != 1) {  
    monitor(&trigger);  
    if (trigger != 1)  
        mwait  
}
```

Only possible in the kernel!

References

- *Scheduler-Conscious Synchronization*
Leonidas I. Kontothanassis, Robert W. Wisniewski, Michael L. Scott
- *Scalable Reader-Writer Synchronization for Shared-Memory Multiprocessors*
John M. Mellor-Crummey, Michael L. Scott
- *Algorithms for Scalable Synchronization on Shared-Memory Multiprocessors*
John M. Mellor-Crummey, Michael L. Scott
- *Concurrent Update on Multiprogrammed Shared Memory Multiprocessors*
Maged M. Michael, Michael L. Scott
- *Scalable Queue-Based Spin Locks with Timeout*
Michael L. Scott and William N. Scherer III
- *Reactive Synchronization Algorithms for Multiprocessors*
B. Lim, A. Agarwal
- *Lock Free Data Structures*
John D. Valois (PhD Thesis)
- *Reduction: A Method for Proving Properties of Parallel Programs*
R. Lipton

References

- *Decoupling Contention Management from Scheduling*
F.R. Johnson, R. Stoica, A. Ailamaki, T. Mowry
- *Corey: An Operating System for Many Cores*
Silas Boyd-Wickizer, Haibo Chen, Rong Chen, Yandong Mao,
Frans Kaashoek, Robert Morris, Aleksey Pesterev, Lex Stein,
Ming Wu, Yuehua Dai, Yang Zhang, Zheng Zhang